

TECH BULLETIN 128



Product changes to crankcase, bearing covers, and shaft protector for all 15 and 18 Frame plunger pumps

Changes have been made to the crankcase and mounting hardware to better support the weight of direct drive bell housings. This affects all 15 and 18 frame plunger pumps with date codes/serial numbers after April 2019. (See reverse side for specific models)

Improvements:

- Crankcase bell housing mounting bolt holes number increased from four (4) to eight (8) to better distribute weight of motor on crankcase.
- Bell housing mounting bolt quantity and sizes changed from four (4) M6 to eight (8) M8 bolts.
- Un-tapped M4.9 - sized grounding wire mounting holes have been added on both sides of the crankcase.
- M4.9 I.D. hole (both sides) can be tapped to a M6 thread.

Functionality Changes:

- Bearing cover bolt holes enlarged (Four [4] x M9) to accommodate M8 bolt size.
- Shaft protector bolt holes enlarged (Two [2] x M9) to accommodate M8 bolt size.

New Crankcase Style

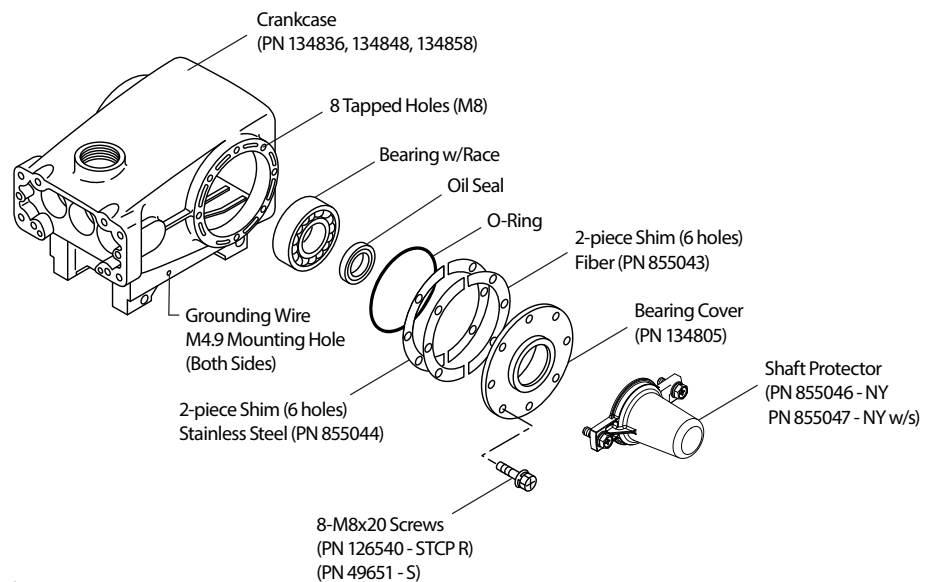

Old Crankcase Style

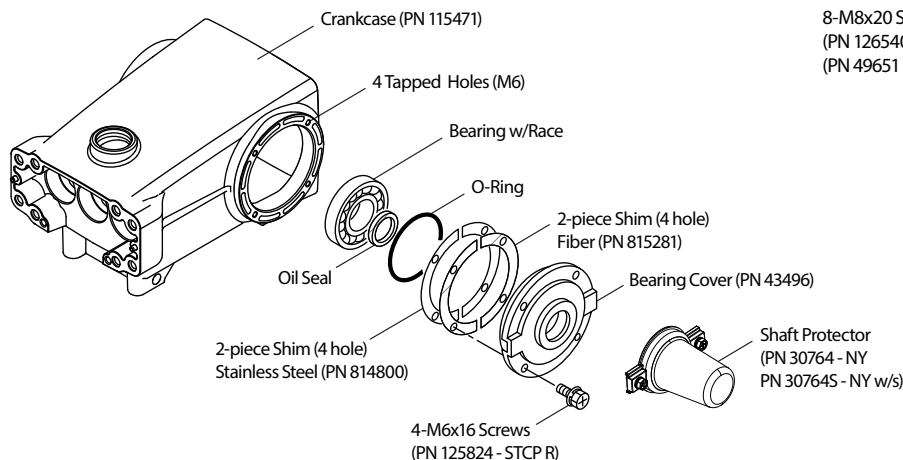

PRODUCTION START DATES

PHASE	MODELS	START DATE
1	640, 650, 660, 661C, 661D	April 2019
2	1050, 1051	May 2019
3	1051C, 1051D, 1057, 1531, 1541, 1541C	October 2019
4	1530, 1540E, 1560, 1570, 1580	January 2020

Cat Pumps

Technical Services Department

99TCH128 Rev A 19167 10/19