

# SERVICE MANUAL

## 3CP STAINLESS STEEL PLUNGER PUMPS

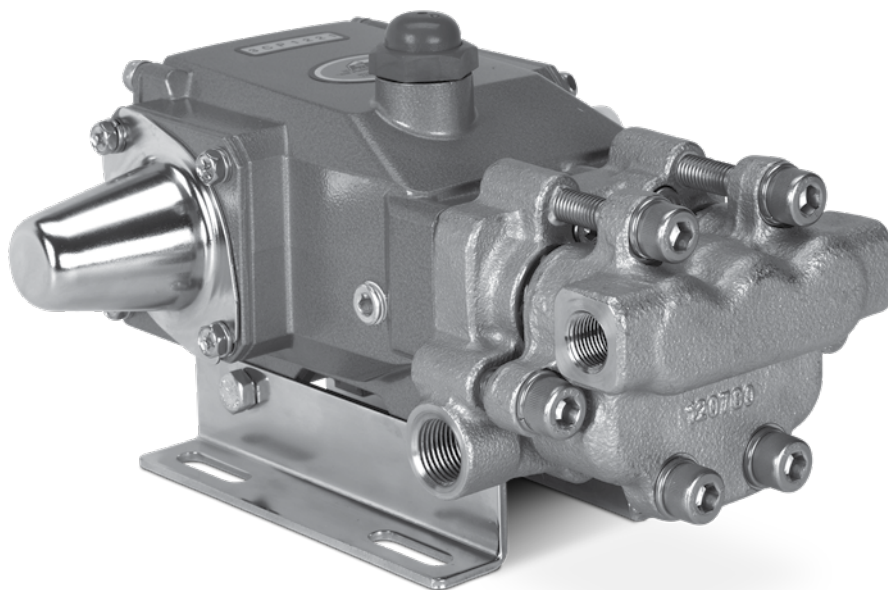

### PUMP MODELS INCLUDED

3CP1211CS	3CP1211G	3CP1221	3CP1231	3CP1241	3CP1241G
-----------	----------	---------	---------	---------	----------

Product Quality, Reliability and Support You Expect

[www.catpumps.com](http://www.catpumps.com)

# Table of Contents

<b>Safety Symbols</b>	2
<b>General Safety Information</b>	3
<b>Seal &amp; Valve Kits</b>	6
Service Intervals	6
<b>Seal &amp; Valve Kit Pump Diagram</b>	7
<b>Tools Needed</b>	7
<b>Servicing the Seals</b>	8
Manifold and Seal Removal	8
Plunger Removal	10
Plunger Reassembly	11
Manifold and Seal Installation	12
<b>Servicing the Valves</b>	16
Valve Removal	16
Valve Installation	18
Discharge Manifold Installation	20
Crankcase Component Inspection	21
<b>Reference Information</b>	22
Preventive Maintenance Schedule	22
Torque Chart	23
Manifold Screws Torque Sequences	23
Technical Bulletin Reference Chart	23
<b>Diagnosis and Maintenance</b>	24

## Safety Symbols

### IMPORTANT SAFETY INSTRUCTIONS

It is the responsibility of the user to read and understand all instructions, important safeguards and safety precautions before operating or servicing any pump. Failure to do so may result in property damage, personal injury or death.

### GENERAL SAFETY INFORMATION AND SYMBOLS

Pay special attention to the following signal words, safety alert symbols and statements:



**DANGER**

Indicates a hazardous situation which, if not avoided, will result in death or serious injury.



**WARNING**

Indicates a hazardous situation which, if not avoided, could result in death or serious injury.



**CAUTION**

Indicates a hazardous situation which, if not avoided, could result in minor or moderate injury or property damage.



**NOTICE**

Indicates a hazardous situation which, if not avoided, could result in property damage.



Indicates a potential personal injury hazard. Obey all safety messages that follow this symbol to avoid possible injury or death.

# General Safety Information

## **⚠ DANGER**

### **A. FLAMMABLE OR EXPLOSIVE LIQUID HAZARD**

Do not operate pump with flammable or explosive liquids unless extraordinary safety precautions are observed. Leaks of flammable or explosive liquids, if exposed to elevated temperatures, static electricity, sparks or other hazards, will result in flame or possible explosion, causing serious personal injury, death or property damage.

1. Before operating pump with flammable or explosive liquids, ensure proper maintenance has been performed.
  2. Do not operate pump with flammable or explosive liquids if leaks are detected.
  3. Only pump flammable or explosive liquids that are compatible with pump component materials.
  4. Do not operate pump with flammable or explosive liquids without safeguards or safety systems to detect leaks, elevated temperatures, spark prevention or any other hazards defined by the NFPA systems.
  5. Do not remove Flammable Liquids Product Suitability Hang Tag to assure proper safety.
  6. Follow ATEX guidelines for potentially-explosive atmospheres.
- 

## **⚠ WARNING**

### **A. ELECTRICAL SHOCK HAZARD**

Do not service pump or electrical equipment while energized. Electricity can cause personal injury, death or property damage.

1. Adhere to "Lock Out" and "Tag Out" procedures for electrical equipment.
2. Before commencing pump service, turn power supply off.
3. Keep water away from electrical outlets and electrical devices.
4. Electrical components must be installed by a qualified electrician to avoid risk of electrocution.

### **B. ROTATING PARTS HAZARD**

Do not service pump while energized. Moving, rotating or reciprocating parts can crush and cut, causing personal injury, death or property damage.

1. Adhere to "Lock Out" and "Tag Out" procedures for electrical equipment.
2. Before commencing pump service, turn power supply off, turn water supply off, squeeze trigger on gun to relieve system pressure.
3. For mobile equipment, be sure engines and hydraulics are turned off and secured to avoid accidental start.
4. Do not operate with safety guards removed.
5. Always use safety guards on all belt drives, couplings and shafts.

### **C. HOT SURFACE HAZARD**

Do not touch pump, accessories or drive system while operating and until cool down is complete. Touching hot surface areas of the pump, accessories or drive system can cause severe burns or personal injury.

### **D. SKIN PUNCTURE HAZARD**

Do not allow spray to contact any part of the body or animals. Pumped liquids under high pressure can pierce skin and underlying tissue or can deflect debris leading to serious personal injury or death.

1. Relieve all line pressure in the inlet line to the pump and discharge line from the pump before performing any maintenance on the pump.
2. When a high-pressure gun is not in use, set safety trigger lock (safety latch) to avoid accidental high-pressure operation and personal injury or property damage.
3. Do not check for leaks with hand. Use a piece of cardboard to check for leaks.
4. Review cleaning procedures to minimize heavy back blasting.
5. Wear adequate safety equipment and clothing when operating a high-pressure sprayer. Never use high-pressure spray with bare feet or exposed skin, and always wear safety glasses.

### **E. PUMPING LIQUIDS HAZARD**

Do not operate pump with hot water, chemicals or other hazardous liquids unless extraordinary safety precautions are observed. Pumping hot water, chemicals or other hazardous liquids can expose personnel to serious injury.

1. Provide guards or shields around equipment to protect personnel.
2. Wear mask, goggles or eye protection while operating high-pressure equipment.
3. Obtain a Safety Data Sheet (SDS) and take appropriate safety measures for the liquid being handled.

# General Safety Information and Symbols

## F. OVER PRESSURIZATION HAZARD **WARNING** CONTINUED

Do not operate high-pressure pumping system unless extraordinary safety precautions are observed. A high-pressure pumping system can deadhead or over pressurize causing serious personal injury and property damage.

1. All high-pressure systems require a primary pressure regulating device (e.g., regulator or unloader) and a secondary pressure safety relief device (e.g., pop-off valve, safety valve, rupture disc) to assure proper pressure setting and overpressure protection.
2. All high-pressure systems require a pressure gauge to monitor pressure settings and avoid overpressure of equipment or personal harm.
3. Install primary pressure relief device on the discharge side of the pump.
4. Install secondary pressure relief device between the primary device and pump.
5. Install pressure gauge onto the discharge manifold or in the discharge line near the manifold.
6. Open all valves on discharge side of plumbing before operation.

## G. OXYGEN HAZARD

Do not charge pulsation dampeners with oxygen. Oxygen may cause an explosion causing personal injury, death or property damage.

1. Use nitrogen only when charging pulsation dampeners, **DO NOT USE OXYGEN**.
2. Use proper charging tools to charge pulsation dampeners.
3. Charge pulsation dampener within specifications stated on data sheet to assure proper pulsation dampening and prevent failure of bladder.

## H. FALL HAZARD

Do not operate pressure washer while standing on slippery or unstable surface unless extraordinary safety precautions are observed. Pressure washing may create slippery surface on which a person may slip and fall causing personal injury or death.

1. Wear suitable footwear to maintain a good grip on wet surfaces.
2. Do not stand on ladders or scaffolding.
3. Do not over reach or stand on unstable supports.
4. Keep good footing and balance and hold gun with both hands to control kick back.

---

## **CAUTION**

### A. IMPROPER USE OF FITTINGS HAZARD

Do not operate the pump with improperly-connected, sized, worn or loose fittings, pipes or hoses. Operating the pump under these conditions could result in personal injury and property damage.

1. Ensure all fittings, pipes and hoses are properly rated for the maximum pressure rating and flow of the pump.
2. Check all fittings and pipes for cracks or damaged threads.
3. Check all hoses for cuts, wear, leaks, kinks or collapse before each use.
4. Ensure all connections are tight and secure.
5. Use PTFE thread tape or pipe thread sealant (sparingly) to reconnect plumbing. Do not wrap tape beyond the last thread, this will prevent loose tape from becoming lodged in the pump or accessories.
6. Apply proper sealants to assure secure fit or easy disassembly when servicing.

### B. FROZEN LIQUID HAZARD

Do not operate the pump with frozen liquid. Operating the pump under this condition could over pressurize and jettison the manifold from the crankcase causing personal injury and property damage.

1. Store pump or pumping system in an environmentally-controlled room protected from freezing temperatures.
2. Follow procedures in *TECH BULLETIN 083* to winterize pump.

### C. CLEANING PUMP HAZARD

Do not use solvents that are flammable and toxic to clean or degrease equipment. Use of these solvents could result in personal injury and property damage.

1. Follow safety instructions as found in SDS or on packaging of each liquid.
2. Clean equipment in a well-ventilated area.
3. Disposal of solvents to be in accordance with local, state and federal regulations.

# General Safety Information and Symbols

## D. OPERATING BEYOND SPECIFICATIONS HAZARD CONTINUED

Do not operate the pump outside the specifications of individual pump data sheet or service manual. Operating the pump under these conditions could result in personal injury and property damage.

1. Do not operate the pump faster than the maximum recommended RPM.
2. Do not operate the pump at pressures higher than the maximum recommended pressure.
3. Do not operate the pump at temperatures higher than the maximum recommended temperatures.
4. Do not use accessories that are not compatible or rated for the pump.

## E. LIFTING DEVICE HAZARD

Do not lift pump with unsuitable lifting devices. Use of unsuitable lifting devices may cause pump to fall, resulting in personal injury, damage to pump and/or pump with drive/base plate.

1. Lifting eyes installed on the pump must be used only to lift the pump.
2. Special lifting eyes should be installed on the base for lifting the pumping system (e.g. base, drive and accessories)
3. If slings or chains are used for lifting, they must be safely and securely attached to properly balance the weight of the unit.
4. Inspect slings and chains prior to use and replace worn and damaged slings and chains.

## NOTICE

### A. OIL HAZARD

Use only genuine Cat Pumps custom-blend, premium-grade, petroleum-based hydraulic oil. Use of other oil may not provide proper lubrication of drive-end components and may result in damage to the crankcase of the pump.

1. Fill pump crankcase to specific capacity indicated on data sheet or service manual prior to startup.
2. Cat Pumps premium custom-blend oil is available worldwide in 21-ounce bottles, (single and 12-pack cases), 2.5 gallon jugs (single and 2-pack) or 30 gallon drums. **Use of other oils may void the warranty.**

### B. PUMP ROTATION DIRECTION HAZARD

Do not rotate pump crankshaft in reverse direction. Rotation of pump crankshaft in reverse direction may not provide proper lubrication and may result in damage to the drive-end components.

1. Forward rotation is the top of the crankshaft turning towards the manifold head of the pump.
2. Ensure oil is filled to the center red dot on sight gauge for forward rotation.
3. If reverse rotation is unavoidable, ensure oil is filled to slightly above center red dot on sight gauge.

### C. BELT TENSION HAZARD

Do not operate pump with excessive belt tension. Excessive belt tension may damage the pump's bearings or reduce horsepower.

1. Rotate pump crankshaft before starting to ensure shaft and bearings are moving freely.
2. Ensure pulleys are properly sized.
3. Periodically replace belts to assure full horsepower transmission.
4. Ensure center distance dimensions between pulleys is correct.

### D. BYPASS OPERATION HAZARD

Do not operate the pump in bypass for extended lengths of time. Operating the pump under this condition can quickly cause heat build-up resulting in damage to the pump.

1. Route bypass line to supply reservoir to dissipate heated bypass liquid into a large reservoir of cool water to reduce excessive temperature build-up.
2. Route bypass line to inlet of pump using a thermo valve in the bypass line or auto shut-off assembly that will sense temperature rise and either bypass or shut down system before damage occurs.

### E. DRY OPERATION HAZARD

Do not operate the pump without water or liquid. Operating pump under these conditions could result in damage to the pump.

1. Open all valves on inlet side of pump before starting operation to prevent starving the pump.
2. Do not exceed inlet suction pressure limit specified in pump data sheet.
3. Ensure inlet feed exceeds the maximum flow being delivered by the pump.
4. Ensure all fittings, pipes and hoses are properly-sized for the pump to avoid restricted flow.
5. Review and implement all other recommendations appropriate for your system from the *Inlet Condition Check-List*.

# Seal & Valve Kits

## SERVICE INTERVALS

Typically, plunger pumps require only a very basic standard maintenance procedure of regular oil changes and seal and valve replacement. Seal and valve life are extremely dependent upon the type of pumped liquid, temperature, inlet conditions, system protective devices, filtration, duty-cycle and maintenance-cycle. Most system failures are not due to the pump, but fail because of other system components.

The Preventative Maintenance Check-List (on page 22) provides a summary of the various system maintenance concerns for all high-pressure systems.

The seals on our pumps, operating under normal conditions, will perform for a minimum of 1500 hours, with most lasting much longer. The valves typically perform for 3000 hours, with many lasting much longer. Cat Pumps always recommends replacing these items as a kit since components usually wear at about the same rate.

Standard NBR kits shown below. See Data Sheets 993104 or 99DAT019 for alternative seal options.

## SEAL KIT

PN 33985 | Qty 1



## VALVE KITS

PN 30982 | Qty 1

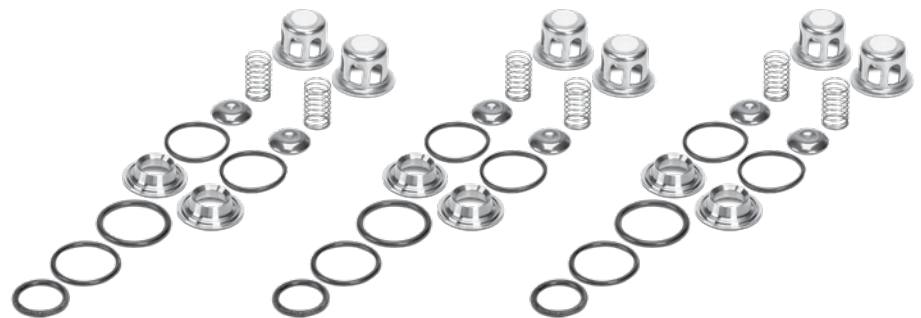

# Seal & Valve Kit Pump Diagram

## ● SEAL KIT COMPONENTS

PN 33985 | Qty 1

## ■ VALVE KIT COMPONENTS

PN 30982 | Qty 1

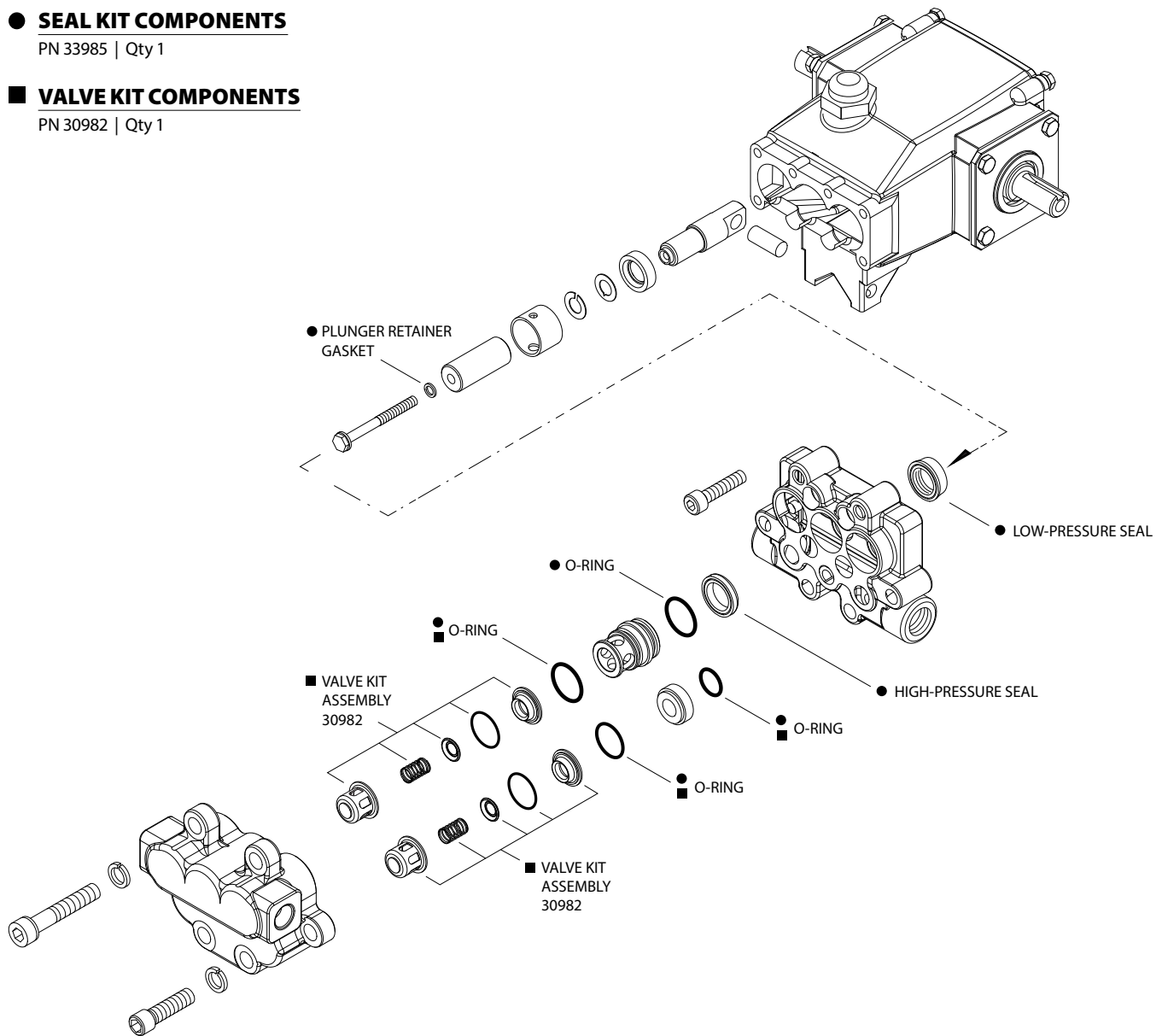

## Tools Needed

1. 6 mm Hex Bit Socket with Ratchet
2. 8 mm Hex Bit Socket with Ratchet
3. 2x Large Flat Tip Screwdrivers
4. Pick
5. Needle Nose Pliers
6. Reverse Pliers (PN 30696)
7. Adjustable Wrench
8. 10 mm Combination Wrench
9. Rubber Mallet
10. Oil Bubble Gauge Tool
11. Anti-Seize (PN 6139)
12. Lubricating Oil
13. Liquid Thread Sealant



# Servicing the Seals

## MANIFOLD AND SEAL REMOVAL

**NOTE:** One (1) seal kit is required to repair the pump (see data sheets PN 993104 or 99DAT019).

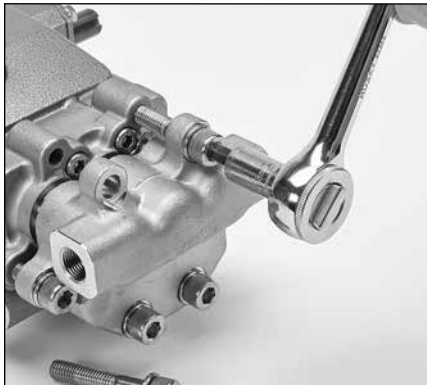

1.01 Use an 8 mm hex bit socket with ratchet to remove the six (6) hex socket head (HSH) screws from the discharge manifold.



1.02 Support the discharge manifold from underneath. Using a rubber mallet, tap the manifold to separate from the inlet manifold and remove completely.

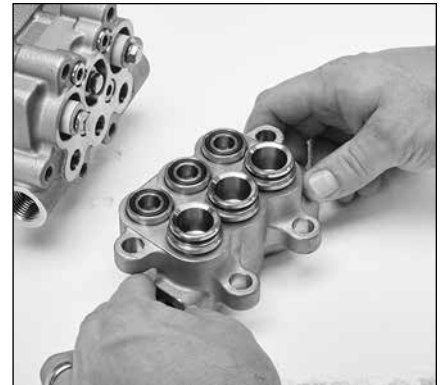

1.03 Place the discharge manifold on a flat surface with valve adapters facing up, and set aside.



1.04 Use a 6 mm hex bit socket with ratchet to remove the four (4) HSH screws from the inlet manifold.

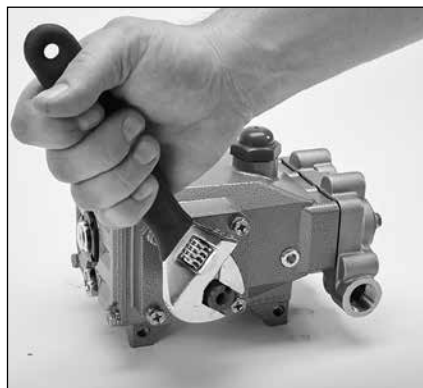

1.05 Rotate the crankshaft with an adjustable wrench to create separation between the manifold and crankcase.

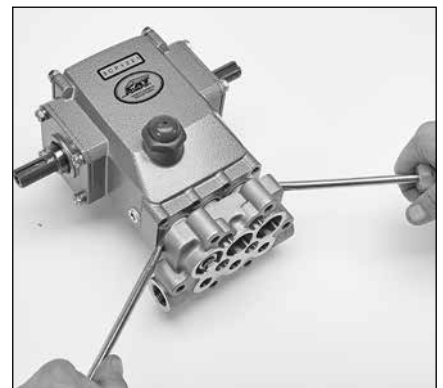

1.06 Insert two (2) flat tip screwdrivers on opposite sides to pry the manifold away from the crankcase.

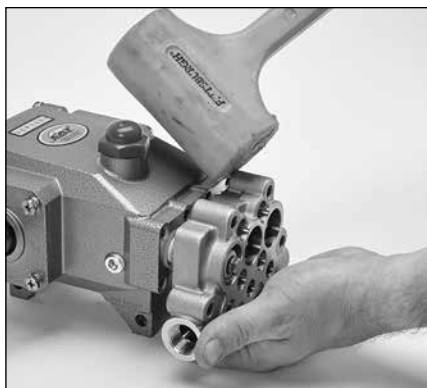

1.07 Support the manifold from underneath. Using a rubber mallet, tap the manifold to separate from the crankcase and remove completely.

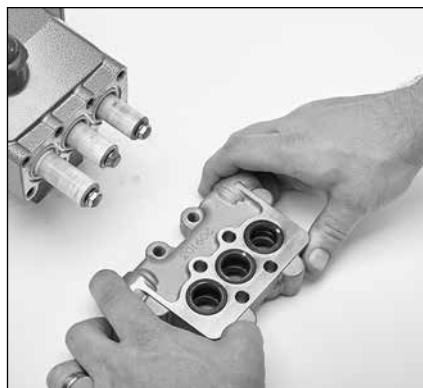

1.08 Place the inlet manifold on a flat surface with the low-pressure seals facing up.



1.09 Use a flat tip screwdriver to pry the low-pressure seals upward and remove.

### NOTICE

Be careful not to score the inside of the manifold.



# Servicing the Seals

## MANIFOLD AND SEAL REMOVAL



1.10 Inspect the inside diameter of the low-pressure seals for wear or damage.

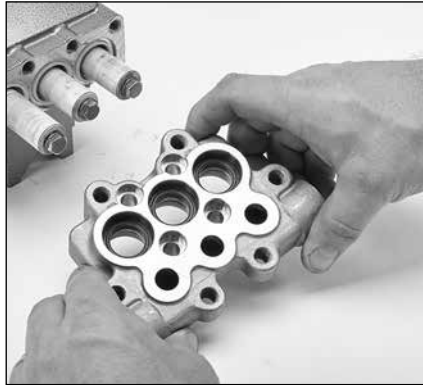

1.11 Flip the inlet manifold over so the high-pressure seals are facing upwards.



1.12 Use a flat tip screwdriver to pry the high-pressure seals upward and remove.

### NOTICE

Be careful not to score the inside of the manifold.

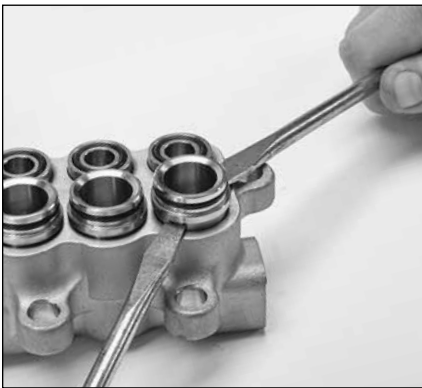

1.13 Insert two (2) flat tip screwdrivers on opposite sides of the discharge valve adapter to pry upwards. Remove from the discharge manifold.



1.14 Using a pick, remove the front discharge valve adapter O-ring. Inspect O-ring for cuts, nicks or damage.



1.15 Using a pick, remove the rear discharge valve adapter O-ring. Inspect O-ring for cuts, nicks or damage.

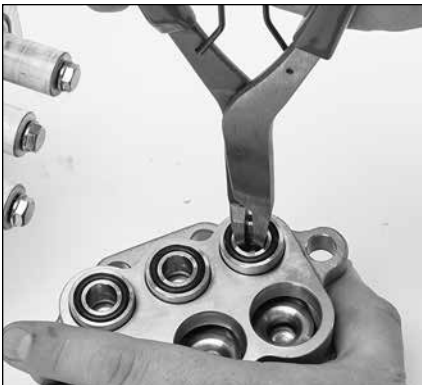

1.16 Using a reverse pliers, grasp the inside diameter of the inlet valve adapter. Remove with a twisting motion.



1.17 Remove the front inlet valve adapter O-ring. Inspect O-ring for cuts, nicks or damage.



1.18 Using a pick, remove the rear inlet valve adapter O-ring. Inspect O-ring for cuts, nicks or damage.

**NOTE:** If replacing valve kit assemblies, continue to Valve Removal 2.07. Continue with Plunger Removal after completing Valve Removal.

# Servicing the Seals

## PLUNGER REMOVAL

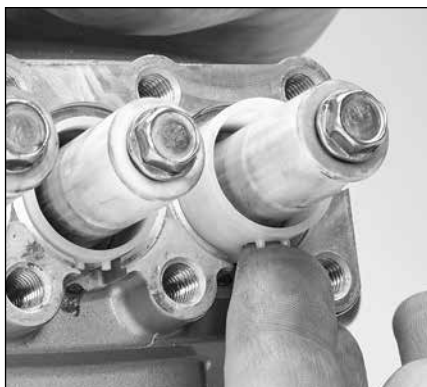

1.19 Remove seal retainer from crankcase housing.



1.20 Using a 10 mm combination wrench, loosen and remove the plunger retainer and plunger.



1.21 Remove and inspect plunger retainer gasket.



1.22 Inspect ceramic plunger for cracks and scoring to the surface. Clean with a wire-wheel brush if necessary.



1.23 Use a pick to remove keyhole washer and barrier slinger located behind the plunger. Inspect for damage.

# Servicing the Seals

## PLUNGER REASSEMBLY



1.24 Install barrier slinger with dish side facing away from crankcase.



1.25 Install keyhole washer. The slot can face any direction.



1.26 Replace plunger retainer gasket with new one from seal kit and apply a lubricant to the outside surface.



1.27 Look for stepped side of plunger. This side goes towards the pump crankcase.



1.28 Insert plunger retainer with gasket into non-stepped side of plunger.



1.29 Place a drop of Loctite® 242® on the threaded end of the plunger rod.



1.30 Thread plunger assembly into plunger rod by hand, and torque to 55 in-lbs, 4.6 ft-lbs or 6.2 Nm.

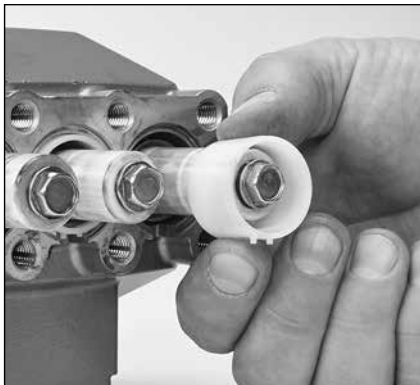

1.31 Install seal retainer with tabs facing down.

Loctite and 242 are registered trademarks of the Henkel Corporation.

# Servicing the Seals

## MANIFOLD AND SEAL INSTALLATION

**NOTICE:** Examine manifold for grooves, pitting or wear and replace as needed.

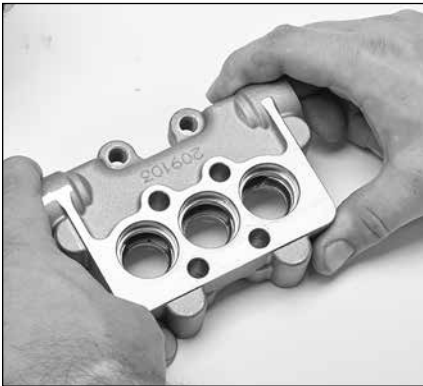

1.32 Place inlet manifold on a flat surface with the low-pressure seal bores facing up.



1.33 Apply a lubricant to the outside surface of the low-pressure seals.



1.34 One side of the low-pressure seal has a groove and spring. Install groove side facing down and press into place.



1.35 Rotate crankshaft so outside two plungers are even at furthest distance from crankcase.

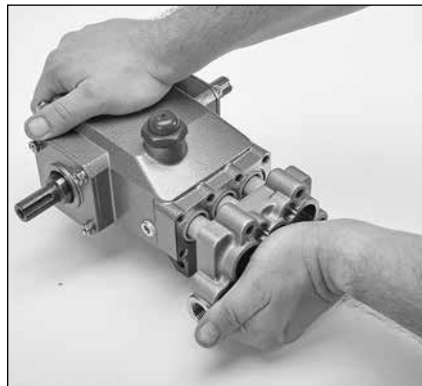

1.36 Install inlet manifold by hand, ensuring even alignment.



1.37 Use a rubber mallet to tap manifold on the rest of the way.



1.38 Apply a lubricant to the outside surface of the high-pressure seals.



1.39 One side of the high-pressure seal has a groove. Install groove side facing out and press into place.

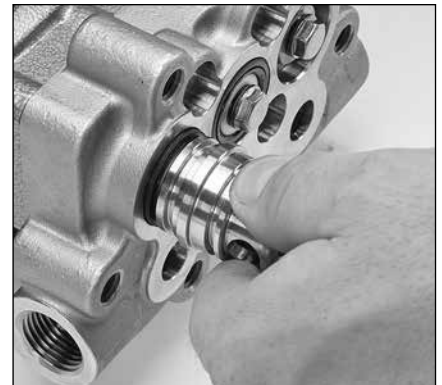

1.40 Using the larger diameter side of the discharge valve adapter without O-rings, press high-pressure seal into its bore.

# Servicing the Seals

## MANIFOLD AND SEAL INSTALLATION

**NOTICE:** Examine manifold for grooves, pitting or wear and replace as needed.

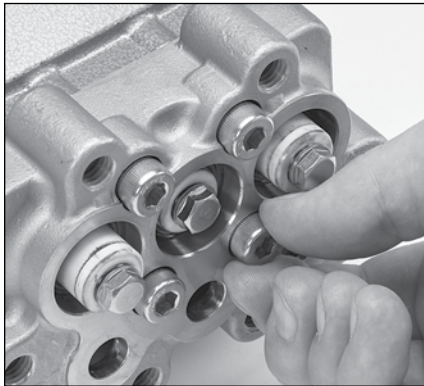

1.41 Install four (4) HSH screws by hand.

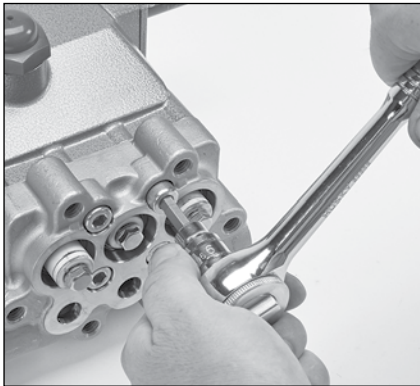

1.42 Using a 6 mm hex socket bit, tighten hex head screws using appropriate cross-pattern for even alignment. Torque to 115 in-lbs, 9.58 ft-lbs, or 13 Nm.

**NOTE:** If replacing valve kit assemblies, continue to Valve Installation 2.20, then proceed to Discharge Manifold Installation.

### TORQUE PATTERN

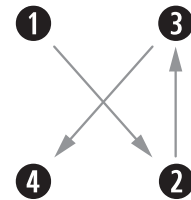

1.43 Replace rear discharge valve adapter O-ring with new one from seal kit and apply a lubricant to outside surface.



1.44 Replace front discharge valve adapter O-ring with new one from seal kit and apply a lubricant to outside surface.

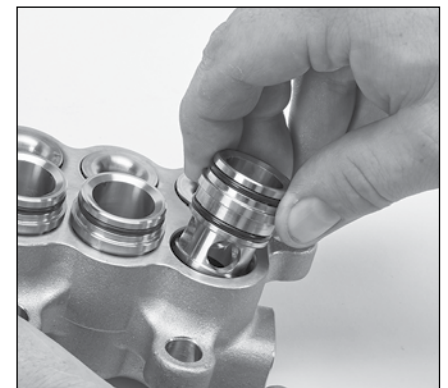

1.45 With smaller side facing down, install discharge valve adapter into discharge manifold bore. Twist and press into place.



1.46 Replace rear inlet valve adapter O-ring with new one from seal kit and apply a lubricant to outside surface.



1.47 Replace front inlet valve adapter O-ring with new one from seal kit and apply a lubricant to outside surface.



1.48 With larger O-ring side facing down, install inlet valve adapter into inlet manifold bore. Twist and press into place.

# Servicing the Seals

## MANIFOLD AND SEAL INSTALLATION

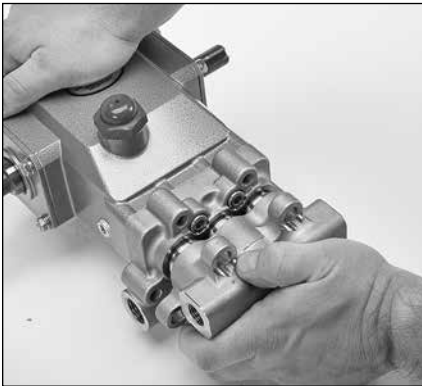

1.49 Install discharge manifold by hand, ensuring even alignment.

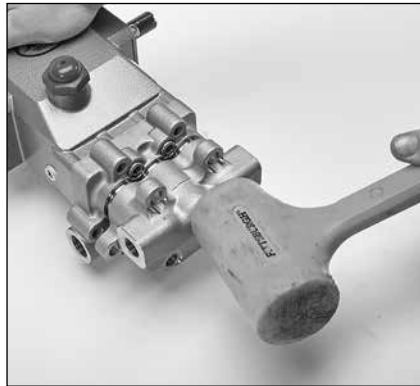

1.50 Use a rubber mallet to tap manifold on the rest of the way.



1.51 Apply anti-seize to the six (6) HSH screws.

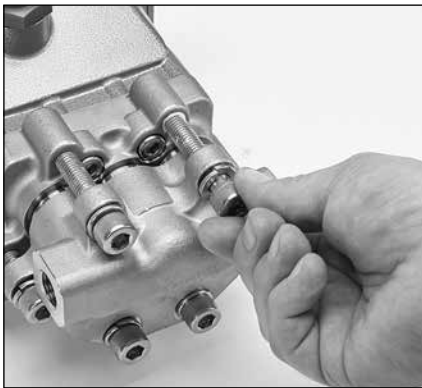

1.52 Install six (6) HSH screws by hand.

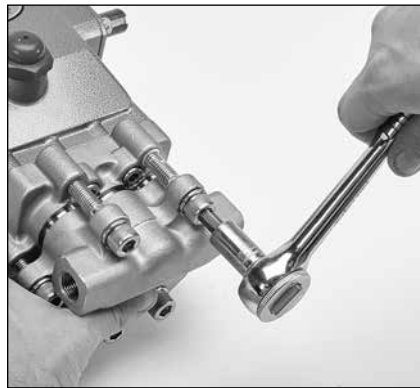

1.53 Using an 8 mm hex socket bit, tighten hex head screws using appropriate cross-pattern for even alignment. Torque to 144 in-lbs, 12.0 ft-lbs, or 16 Nm.

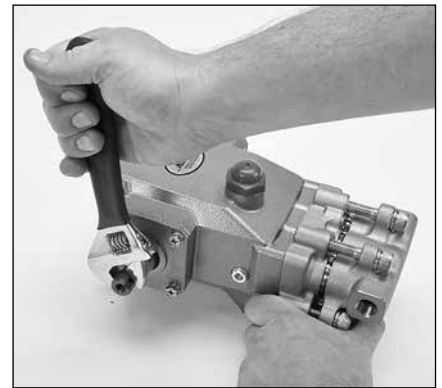

1.54 Rotate crankshaft with adjustable wrench to ensure proper movement of plunger rod assemblies and that seals are not binding.

## TORQUE PATTERN

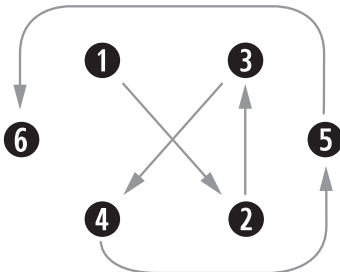



# Servicing the Valves

## VALVE REMOVAL

**NOTE:** One (1) valve kit is required to repair the pump (see data sheets PN 993104 or 99DAT019).

**NOTE:** Discharge and inlet valve assemblies are identical (use procedure below for disassembly and reassembly of discharge and inlet valves).

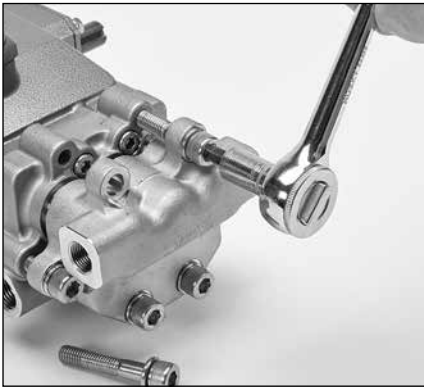

2.01 Use an 8 mm hex bit socket with ratchet to remove the six (6) hex socket head (HSH) screws from the discharge manifold.



2.02 Support the discharge manifold from underneath. Using a rubber mallet, tap the manifold to separate from the inlet manifold and remove completely.

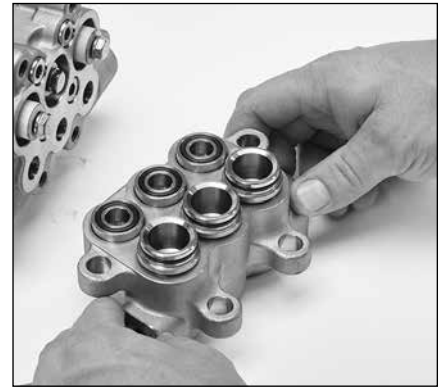

2.03 Place the discharge manifold on a flat surface with valve adapters facing up.

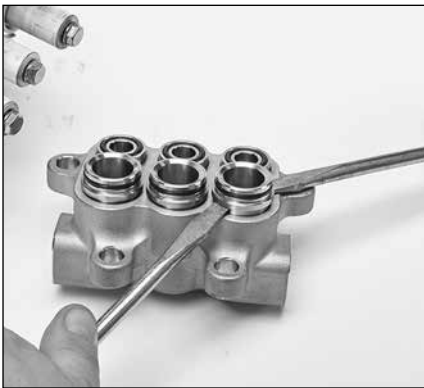

2.04 Insert two (2) flat tip screwdrivers on opposite sides of the discharge valve adapter to pry upwards. Remove from the discharge manifold.



2.05 Using a pick, remove the front discharge valve adapter O-ring. Inspect O-ring for cuts, nicks or damage.



2.06 Using a pick, remove the discharge valve seat. Inspect tapered surface of the valve seat for wear, pitting or damage.

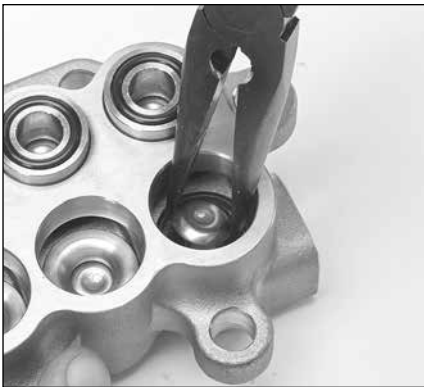

2.07 Using a needle-nosed pliers, remove the discharge valve. Inspect tapered surface of the valve for wear, pitting or damage.



2.08 Using a needle-nosed pliers, remove the spring. Check for proper tension or any damage.



2.09 Remove the valve seat O-ring. Inspect O-ring for cuts, nicks or damage.



# Servicing the Valves

## VALVE REMOVAL

**NOTICE:** Pitting on the valve seat or valve is an indication of cavitation. Review our Cavitation Troubleshooting Support Document for assistance. [www.catpumps.com/cavitation-troubleshooting](http://www.catpumps.com/cavitation-troubleshooting)



2.10 Remove the discharge spring retainer. Inspect for cracks, excessive wear or damage.



2.11 Using a reverse pliers, grasp the inside diameter of the inlet valve adapter. Remove with a twisting motion.

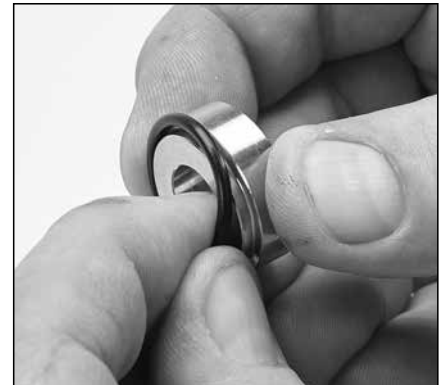

2.12 Remove the front inlet valve adapter O-ring. Inspect O-ring for cuts, nicks or damage.



2.13 Using a pick, remove the rear inlet valve adapter O-ring. Inspect O-ring for cuts, nicks or damage.



2.14 Using a pick, remove the inlet valve seat. Inspect tapered surface of the valve seat for wear, pitting or damage.



2.15 Remove the inlet valve. Inspect tapered surface of the valve for wear, pitting or damage.



2.16 Remove the spring. Check for proper tension or any damage.



2.17 Remove the valve seat O-ring. Inspect O-ring for cuts, nicks or damage.



2.18 Remove the inlet spring retainer. Inspect for cracks, excessive wear or damage.

# Servicing the Valves

## VALVE INSTALLATION



2.19 Install spring retainer with white notch facing down into the inlet valve bore.



2.20 Lubricate and install valve seat O-ring into the inlet valve bore.



2.21 Place the spring onto the guide in the spring retainer.



2.22 Place the valve onto the spring with concave side facing down.



2.23 Place the valve seat onto the valve with the tapered surface facing down.



2.24 Replace rear inlet valve adapter O-ring with new one from seal kit and apply a lubricant to outside surface.



2.25 Replace front inlet valve adapter O-ring with new one from seal kit and apply a lubricant to outside surface.



2.26 With larger O-ring side facing down, install inlet valve adapter into inlet manifold bore. Twist and press into place.



2.27 Install spring retainer with white notch facing down into the discharge valve bore.

# Servicing the Valves

## VALVE INSTALLATION



2.28 Lubricate and install valve seat O-ring into the discharge valve bore.



2.29 Place the spring onto the guide in the spring retainer.



2.30 Place the valve onto the spring with concave side facing down.



2.31 Place the valve seat onto the valve with the tapered surface facing down.



2.32 Replace front discharge valve adapter O-ring with new one from seal kit and apply a lubricant to outside surface.



2.33 With smaller side facing down, install discharge valve adapter into discharge manifold bore. Twist and press into place.

# Servicing the Valves

## DISCHARGE MANIFOLD INSTALLATION

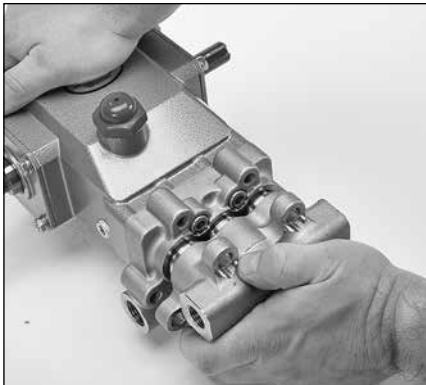

2.34 Install discharge manifold by hand, ensuring even alignment.

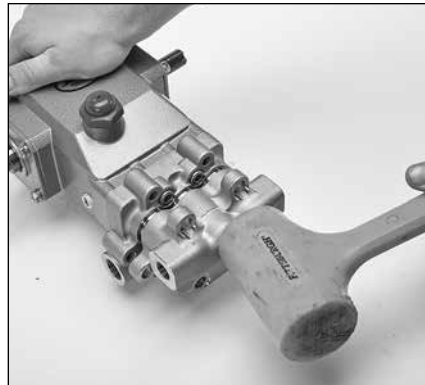

2.35 Use a rubber mallet to tap manifold on the rest of the way.



2.36 Apply anti-seize to the six (6) HSH screws.

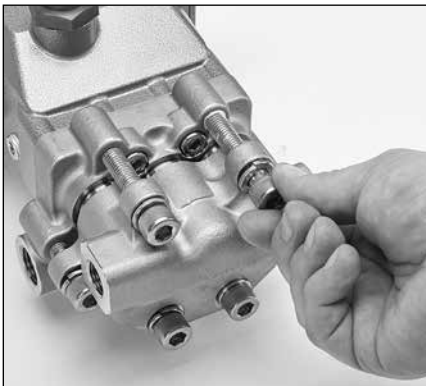

2.37 Install six (6) HSH screws by hand.

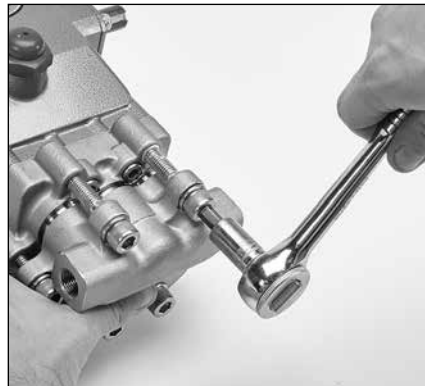

2.38 Using an 8 mm hex socket bit, tighten hex head screws using appropriate cross-pattern for even alignment. Torque to 144 in-lbs, 12.0 ft-lbs, or 16 Nm.

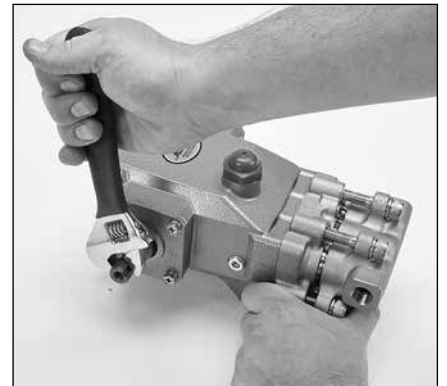

2.39 Rotate crankshaft with adjustable wrench to ensure proper movement of plunger rod assemblies and that seals are not binding.

### TORQUE PATTERN

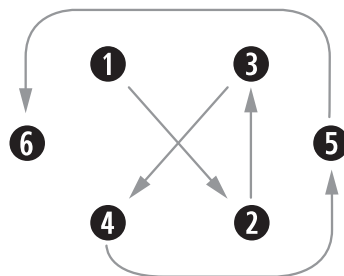

## CRANKCASE COMPONENT INSPECTION

Inspection of the crankcase for leaks is an essential step in the preventive maintenance of a pump. Worn seals and O-rings not only can create a mess with leaking oil, but can lead to premature parts wear and damage due to low crankcase oil level.

Crankcase oil that appears cloudy or milky in the Oil Bubble Gauge indicates the presence of water in the crankcase. A water/oil mix does not provide enough lubrication to the components in the drive end and will cause damage. This damage can occur on the plunger rods or the crankshaft and connecting rods. Also, without a layer of oil on the drive end components, oxidation and rust will form on the bearings and crankshaft. If contamination is suspected, inspect and replace the seals in the pump manifold, then clean out the inside of the crankcase and change the oil.

Spot-check the following areas for signs of leaks and contact Cat Pumps or a local distributor for servicing crankcase if needed.

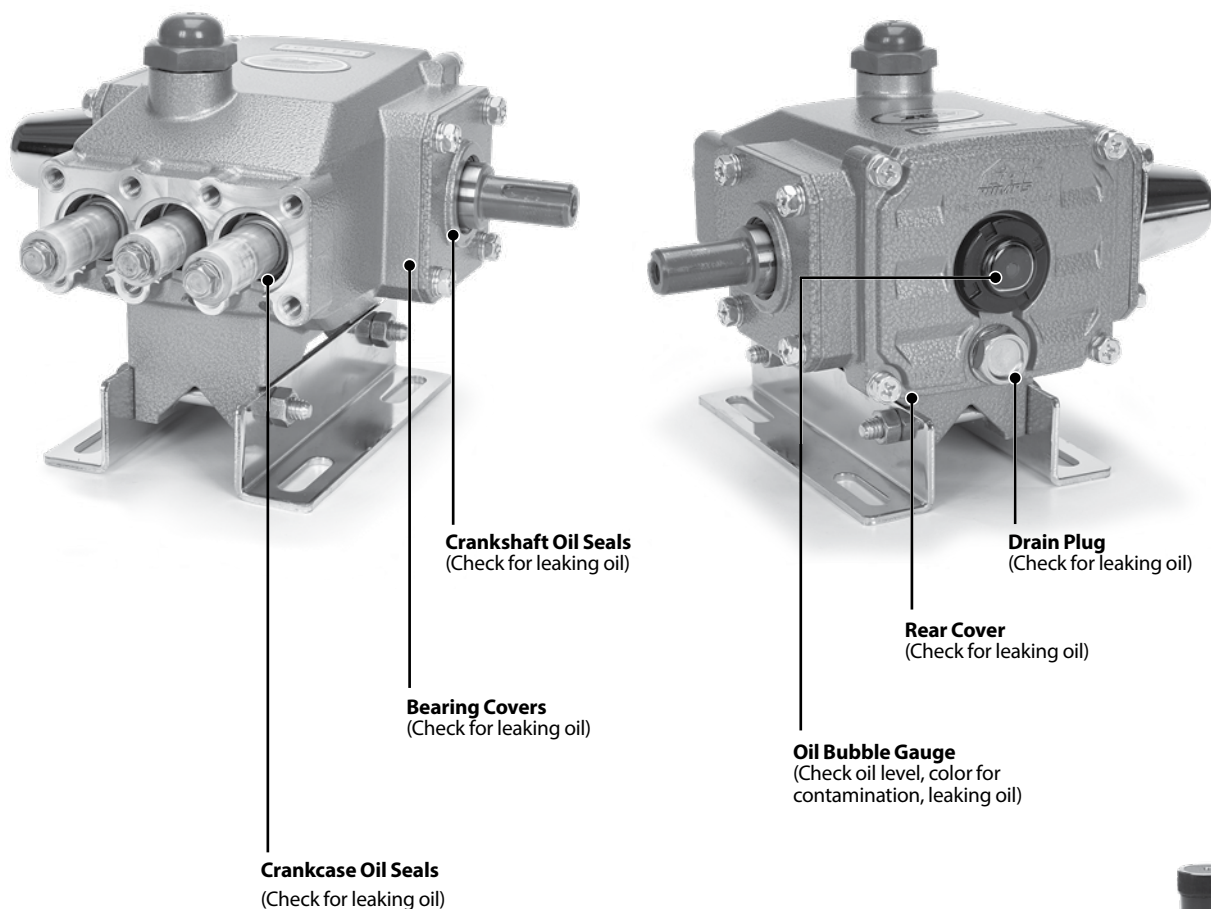

Cat Pumps custom blend crankcase oil is exclusively designed, tested and proven to maximize the life of your pump. This special formulated premium-grade, petroleum-based, ISO 68 hydraulic oil contains the most advanced additive package to protect against wear, oxidation, rust and corrosion.

Cat Pumps premium custom-blend oil is available worldwide in 21-ounce bottles, (single and 12-pack cases), 2.5 gallon jugs (single and 2-pack) or 30 gallon drums. **Use of other oils may void the warranty.**



# Reference Information

## PREVENTIVE MAINTENANCE SCHEDULE

Many application factors determine proper pump maintenance intervals. Variation in duty cycle, operating performance, fluid temperature, fluid type, inlet conditions and application environment can affect maintenance schedules. Every application should be evaluated and serviced based on its own requirements. The following checklist is intended as a reference guide only.

CHECK	DAILY		WEEKLY	50 HRS.	500 HRS.	1500 HRS.	3000 HRS.
Filters	•	or	•				
Oil Level/Quality	•	or	•	①	①		
Water Leaks	•	or	•				
Oil Leaks	•						
Plumbing			•				
Belts, Pulley			•				
Accessories						•	
Seals						②	
Valves							③

Water leaks or loss of system performance can be an indicator of seal wear. Seal wear has many causes, including contaminated liquid or high-temperature/run dry operation. If the low-pressure seals show wear, the high-pressure seals most likely are in a similar condition. It is a good practice to replace both low and high-pressure seals and inspect plungers when leaks are present.

- ① Cat Pumps recommends using our custom-blend premium grade hydraulic oil formulated to meet Cat Pumps specifications. For best results, perform an initial oil change after the first 50 hours of operation and every 500 hours thereafter.
- ② Every system operates under different conditions. Past performance and maintenance history are the best indicators of future performance. If system performance degrades or changes, check seals and valves immediately. Service as required to restore system performance. Depending upon operating conditions, maintenance intervals for seals kits range between 1,500 and 8,000 hours.
- ③ Pump valves typically require changing every other seal change. If system performance degrades or changes, check valves immediately. Depending upon operating conditions, maintenance intervals for valve kits range between 3,000 and 16,000 hours.

# Reference Information

## TORQUE CHART

PUMP ITEM	THREAD	TOOL SIZE	TOOL PART NUMBER	TORQUE		
				IN-LBS	FT-LBS	Nm
Plunger Retainers	M6	10 mm Combination Wrench	—	55	4.6	6.2
Inlet Manifold Screws	M8	6 mm Hex Bit Socket with Ratchet		115	9.58	13
Discharge Manifold Screws	M10	8 mm Hex Bit Socket with Ratchet	—	144	12.0	16.0
Rear Cover Screws	M6	10 mm Combination Wrench	—	50	4.0	5.4
Bearing Cover Screws	M6	10 mm Combination Wrench	—	50	4.0	5.4
Connecting Rod Screws	M7	10 mm Combination Wrench	—	95	8.0	11.0
Bubble Oil Gauge	M28	Oil Gauge Tool	44050	45	3.8	5.0
Direct Mount Screws	M8	13 mm Combination Wrench	—	115	9.58	13.0

## MANIFOLD SCREWS TORQUE SEQUENCES

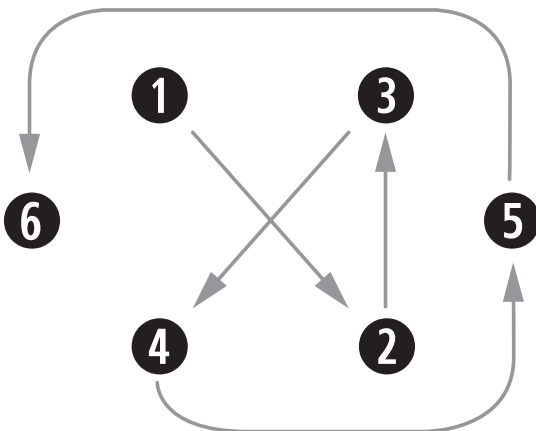
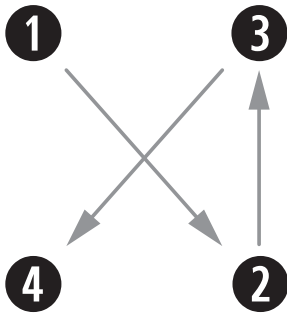

## TECHNICAL BULLETIN REFERENCE CHART

NO.	SUBJECT	MODELS
002	Inlet Pressure vs. Water Temperature	All Models
034	Servicing Crankcase Section – Ball Bearing Models	3FR, 4FR, 5FR, 10FR, 25FR, 3CP, 5CP, 3PFR, 5PFR, 25PFR, 28PFR
036	Identifying Your Pump	All Models
043	Servicing the Low and High Pressure Seals	All Plunger Models
053	Liquid Gasket for Seal and Valve Servicing	All Plunger NAB and SS Models
074	Torque Chart	All Models
083	Winterizing a Pump	All Models
088	6-Bolt SS Manifold	All SS 3CP, 5CP Models
095	Galling Prevention	All Stainless Steel Models
134	Piston and Plunger Pump Crankcase Capacities	Piston and Plunger Pumps

# Diagnosis and Maintenance

This service manual is designed to assist you with the disassembly and reassembly of your pump. The following guide will assist in determining the cause and remedy to various operating conditions. You can also review our **FAQ** or **SERVICE** sections on our **WEB SITE** for more facts or contact Cat Pumps directly.

PROBLEM	PROBABLE CAUSE	SOLUTION
<b>Low pressure</b>	<ul style="list-style-type: none"> <li>• Worn nozzle.</li> <li>• Air leak in inlet plumbing.</li> <li>• Pressure gauge inoperative or not registering accurately.</li> <li>• Relief valve stuck, partially plugged or improperly adjusted.</li> <li>• Inlet suction strainer (filter) clogged or improperly sized.</li> <li>• Abrasives in pumped liquid.</li> <li>• Leaky discharge hose.</li> <li>• Inadequate liquid supply.</li> <li>• Severe cavitation.</li> <li>• Worn seals.</li> <li>• Worn or dirty inlet/discharge valves.</li> </ul>	<ul style="list-style-type: none"> <li>• Replace with proper size nozzle.</li> <li>• Tighten fittings and hoses. Use PTFE liquid or tape.</li> <li>• Check with new gauge. Replace worn or damaged gauge.</li> <li>• Clean/adjust relief valve. Replace worn seats/valves and O-rings.</li> <li>• Clean filter. Use adequate size filter. Check more frequently.</li> <li>• Install proper filter.</li> <li>• Replace discharge hose with proper rating for system.</li> <li>• Pressurize inlet.</li> <li>• Check inlet conditions.</li> <li>• Install new seal kit. Increase frequency of service.</li> <li>• Clean inlet/discharge valves or install new valve kit.</li> </ul>
<b>Pulsation</b>	<ul style="list-style-type: none"> <li>• Foreign material trapped in inlet/discharge valves.</li> </ul>	<ul style="list-style-type: none"> <li>• Clean inlet/discharge valves or install new valve kit.</li> </ul>
<b>Water leak</b>		
<ul style="list-style-type: none"> <li>• Under the manifold</li> <li>• Into the crankcase</li> </ul>	<ul style="list-style-type: none"> <li>• Worn high-pressure or low-pressure seals.</li> <li>• Humid air condensing into water inside the crankcase.</li> <li>• Excessive wear to high-pressure or low-pressure seals.</li> </ul>	<ul style="list-style-type: none"> <li>• Install new seal kit. Increase frequency of service.</li> <li>• Install new oil cap protector. Change oil every 3 months or 500 hours.</li> <li>• Install new seal kit. Increase frequency of service.</li> </ul>
<b>Knocking noise</b>		
<ul style="list-style-type: none"> <li>• Inlet supply</li> <li>• Bearing</li> </ul>	<ul style="list-style-type: none"> <li>• Inadequate inlet liquid supply.</li> <li>• Broken or worn bearing.</li> </ul>	<ul style="list-style-type: none"> <li>• Check liquid supply. Increase line size or pressurize.</li> <li>• Replace bearing.</li> </ul>
<b>Oil leak</b>		
<ul style="list-style-type: none"> <li>• Crankcase oil seal</li> <li>• Crankshaft oil seal and O-ring</li> <li>• Drain plug</li> <li>• Bubble gauge</li> <li>• Bearing cover</li> <li>• Filler cap</li> </ul>	<ul style="list-style-type: none"> <li>• Worn crankcase oil seal.</li> <li>• Worn crankshaft oil seal or O-ring on bearing cover.</li> <li>• Loose drain plug or worn drain plug O-ring.</li> <li>• Loose bubble gauge or worn bubble gauge gasket.</li> <li>• Loose bearing cover or worn bearing cover O-ring.</li> <li>• Loose filler cap or excessive oil in crankcase.</li> <li>• Excessive pump RPM.</li> </ul>	<ul style="list-style-type: none"> <li>• Replace crankcase oil seal.</li> <li>• Remove bearing cover and replace O-ring and/or oil seal.</li> <li>• Tighten drain plug or replace O-ring.</li> <li>• Tighten bubble gauge or replace gasket.</li> <li>• Tighten bearing cover or replace O-ring.</li> <li>• Tighten filler cap. Fill crankcase to specified capacity.</li> <li>• Consult pump data sheet for maximum pump RPM. Change pulley sizes or motor/engine RPM.</li> </ul>
<b>Pump runs extremely rough</b>		
<ul style="list-style-type: none"> <li>• Inlet conditions</li> <li>• Pump valves</li> <li>• Pump seals</li> </ul>	<ul style="list-style-type: none"> <li>• Restricted inlet or air entering the inlet plumbing.</li> <li>• Stuck inlet/discharge valves.</li> <li>• Leaking high-pressure or low-pressure seals.</li> </ul>	<ul style="list-style-type: none"> <li>• Correct inlet size plumbing. Check for air tight seal.</li> <li>• Clean out foreign material or install new valve kit.</li> <li>• Install new seal kit. Increase frequency of service.</li> </ul>
<b>Premature seal failure</b>		
	<ul style="list-style-type: none"> <li>• Scored plunger.</li> <li>• Over pressure to inlet manifold.</li> <li>• Abrasive material in the liquid being pumped.</li> <li>• Excessive pressure and/or temperature of pumped liquid.</li> <li>• Running pump dry.</li> <li>• Starving pump of adequate liquid.</li> <li>• Eroded manifold.</li> </ul>	<ul style="list-style-type: none"> <li>• Replace plunger.</li> <li>• Reduce inlet pressure per specifications.</li> <li>• Install proper filtration at pump inlet and clean regularly.</li> <li>• Check pressure and inlet liquid temperature.</li> <li>• Do not run pump without liquid. Fill pump with oil.</li> <li>• Increase hose one size larger than inlet port size or pressurize.</li> <li>• Replace manifold. Check liquid compatibility.</li> </ul>



**CAT PUMPS**  
 1681 - 94TH LANE N.E. MINNEAPOLIS, MN 55449-4324  
 PHONE (763) 780-5440 — FAX (763) 780-2958  
 e-mail: techsupport@catpumps.com  
 www.catpumps.com

For International Inquiries go to [www.catpumps.com](http://www.catpumps.com) and navigate to the "Contact" link.