

SERVICE MANUAL

1570 PLUNGER PUMP



PUMP MODEL	FLOW		PRESSURE		RPM		TEMPERATURE		SHAFT DIA.		OIL CAPACITY	
	gpm	lpm	psi	bar	Pump	Motor	°F	°C	in	mm	oz	l
1570	6.0	22.7	6,000	414	1350	—	120	48	1.181	30	42	1.26

IMPORTANT SAFETY INSTRUCTIONS

It is the responsibility of the user to read and understand all instructions, important safeguards, and safety precautions before operating or servicing any pump. Failure to do so may result in property damage, personal injury or death.

General Safety Information and Symbols

Pay special attention to the following signal words, safety alert symbols and statements:

⚠ DANGER indicates a hazardous situation which, if not avoided, will result in death or serious injury.

⚠ WARNING indicates a hazardous situation which, if not avoided, could result in death or serious injury.

⚠ CAUTION indicates a hazardous situation which, if not avoided, could result in minor or moderate injury or property damage.

NOTICE indicates a hazardous situation which, if not avoided, could result in property damage.

⚠ Indicates a potential personal injury hazard. Obey all safety messages that follow this symbol to avoid possible injury or death.

SERVICING THE 1570 PLUNGER PUMP SERIES

⚠ WARNING

Do not service pump or electrical equipment while energized.

Electricity can cause personal injury, death or property damage.

1. Adhere to "Lock Out" and "Tag Out" procedures for electrical equipment.
2. Before commencing pump service, turn power supply off.
3. Keep water away from electrical outlets and electrical devices.
4. Electrical components must be installed by a qualified electrician to avoid risk of electrocution.

Servicing the Valves

DISASSEMBLY (DISCHARGE VALVES ONLY)

NOTE: One (1) valve kit is required to repair pump.

NOTE: The discharge seat has a smaller diameter than the inlet seat.

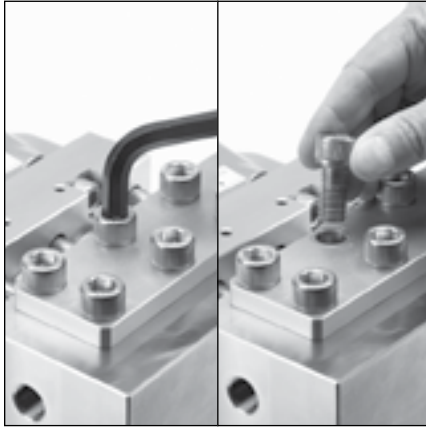

1.0 Use a M10 Allen Wrench to remove the eight (8) Hex Socket Head (HSH) screws from valve cover on IMDM.



1.1 Remove valve cover.



1.2 Use a flat tip screwdriver to remove valve plugs from each valve chamber.



1.3 Use a pick tool to remove backup-ring and o-ring from each valve plug.

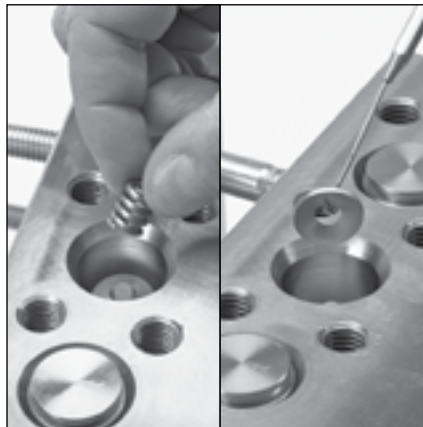

1.4 Remove coil spring and then washer from each valve chamber.



1.5 Use a needle nose pliers to grab the tip end of the spring retainer and pull valve assembly from each valve chamber.

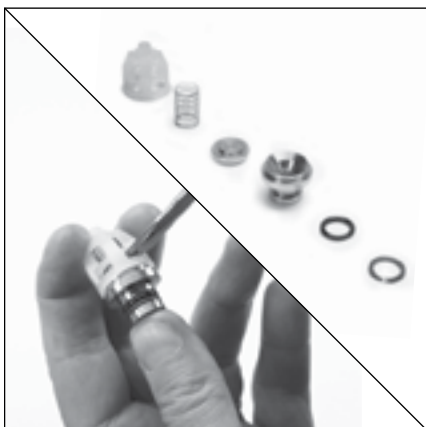

1.6 Disassemble discharge valve assembly and inspect all parts per NOTES

NOTE: Examine seats, valves and springs for grooves, pitting or wear and replace with a new valve kit as needed.

NOTE: Examine o-rings and backup-rings for cuts or wear and replace with a new valve kit as needed.

REASSEMBLY

NOTE: Lubricate o-rings and backup-rings on valve seats and valve plugs prior to reassembly.



1.7 Place new assembled discharge valve assembly into each valve chamber.

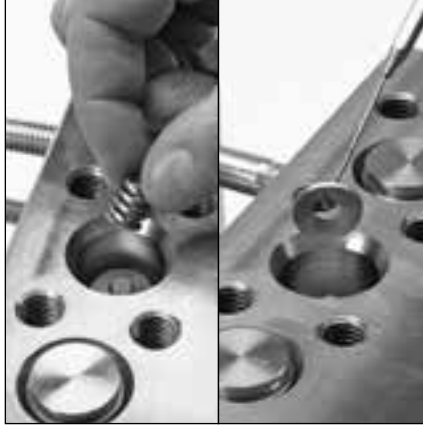

1.8 Place washer over tip of spring retainer and then coil spring.



1.9 Press in valve plug into each valve chamber.



1.10 Place valve cover on top of IMDM and align with threaded holes.



1.11 Apply anti-sieze lubricant (PN 6119) to threads of all eight (8) HSH screws and hand tighten.



1.12 Use a M10 Allen Wrench to torque all eight (8) HSH screws to 398 in lbs, 33 ft lbs or 45 Nm in sequence show.

TORQUE SEQUENCE

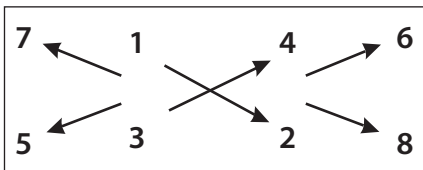

Servicing the Valves

DISASSEMBLY (INLET VALVES ONLY)

NOTE: One (1) valve kit is required to repair pump.

NOTE: In order to remove inlet valve assembly, remove IMDM and housing block.

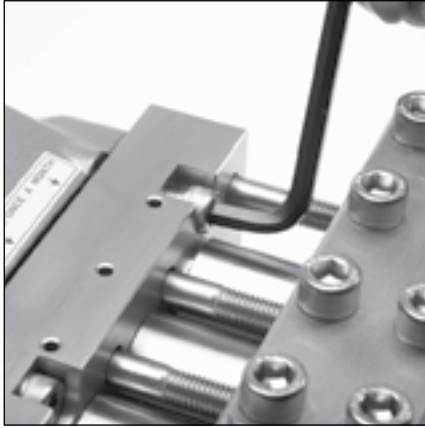

2.0 Use a M8 Allen Wrench to remove the four (4) Hex Socket Head Screws (HSH) that secure the housing block to the crankcase.



2.1 Position two flat tip screwdrivers on either side of housing block and pry the housing block from the crankcase.

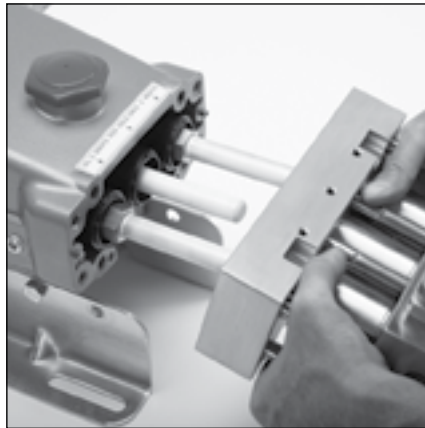

2.2 Pull complete head assembly carefully over ceramic plungers and place on a flat surface with the housing block side facing upwards.

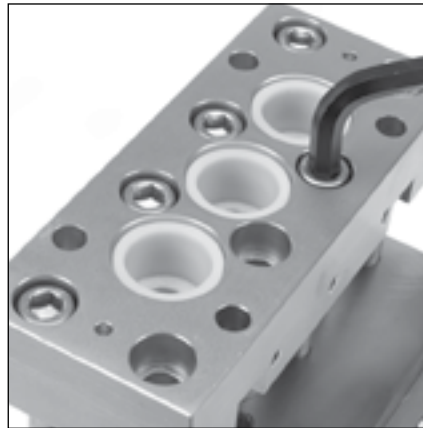

2.3 Use a M10 Allen Wrench to remove the eight (8) HSH screws that secure the housing block to the IMDM.



2.4 Pull housing block away from IMDM.



2.5 Remove outer cylinders with seal case assembly from IMDM.



2.6 Remove V-Packing (V/P) cylinder assembly from each IMDM valve chamber.

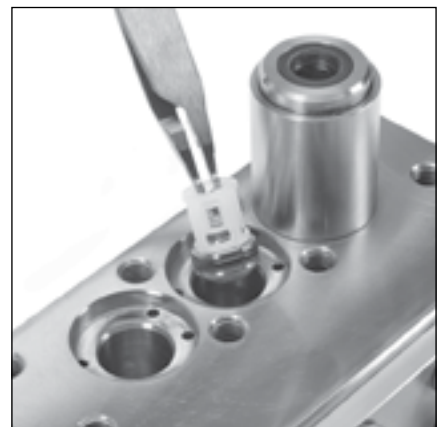

2.7 Use a reverse pliers to grasp spring retainer and pull inlet valve assembly from each valve chamber.



NOTE: Examine seats, valves and springs for grooves, pitting or wear and replace with a new valve kit as needed.

NOTE: Examine o-rings and backup-rings for cuts or wear and replace with a new valve kit as needed.

2.8 Disassemble inlet valve assembly and inspect all parts per NOTES

REASSEMBLY

NOTE: Lubricate o-rings and backup-rings on valve seats and V/P cylinders and o-rings on outer cylinder prior to reassembly.



2.9 Place new assembled inlet valve assembly into each valve chamber.



2.10 Position V/P cylinder assembly into IMDM and hand press into place.



2.11 Slide outer cylinder with seal case assembly and hand press into place.



2.12 Position housing block with counter-bore surfaces facing downward over outer cylinders.

NOTE: Apply anti-sieze lubricant (PN 6119) to threaded ends of all eight (8) HSH screws and hand thread into position.

REASSEMBLY CONTINUED

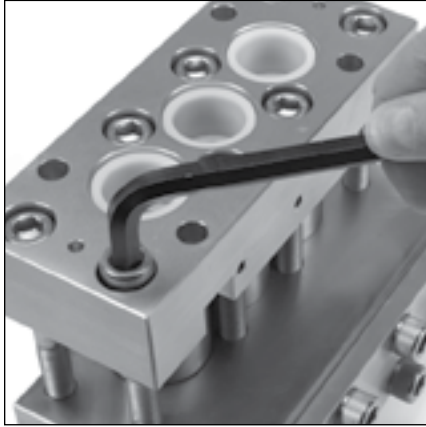

2.13 Use a M10 Allen Wrench to torque all eight (8) HSH screws to 398 in lbs, 33 ft lbs or 45 Nm in sequence show.

TORQUE SEQUENCE

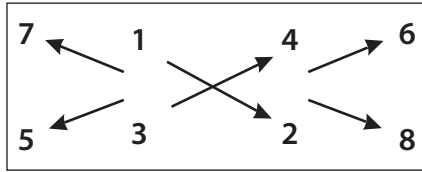

NOTICE

Exercise extreme caution when installing head assembly. The weight of the head assembly or any twisting action can damage the ceramic plungers.

Rotate crankshaft by hand so the two outside plungers are extended equally.

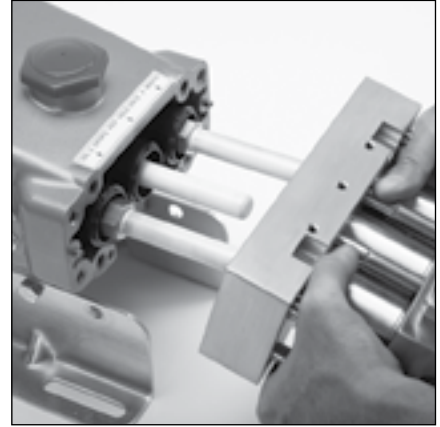

2.14 Slide complete head assembly carefully over ceramic plungers until flush against crankcase.

NOTE: Apply Loctite®242® to threaded ends of all four (4) HSH screws and hand thread into position.

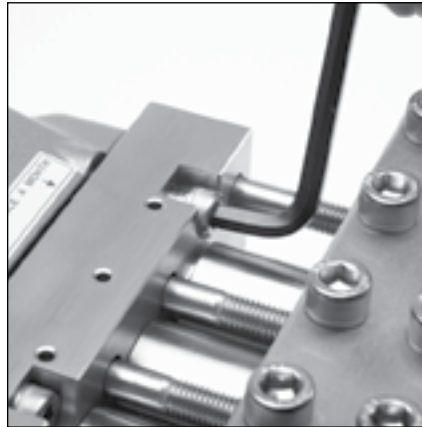

2.15 Use a M8 Allen Wrench to torque all four (4) HSH screws to 531 in lbs, 44 ft lbs or 60 Nm in sequence show.

TORQUE SEQUENCE

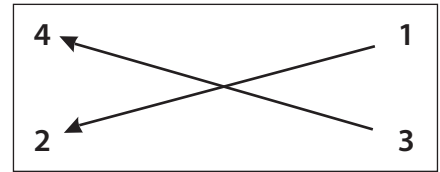

Servicing the Seals

DISASSEMBLY

NOTE: One (1) seal kit is required to repair pump.

NOTE: In order to replace seals, remove IMDM and housing block.



3.0 Use a M8 Allen Wrench to remove the four (4) Hex Socket Head Screws (HSH) that secure the housing block to the crankcase.

NOTICE

Exercise extreme caution when removing head assembly. The weight of the head assembly or any twisting action can damage the ceramic plungers.



3.1 Position two flat tip screwdrivers on either side of housing block and pry the housing block from the crankcase.

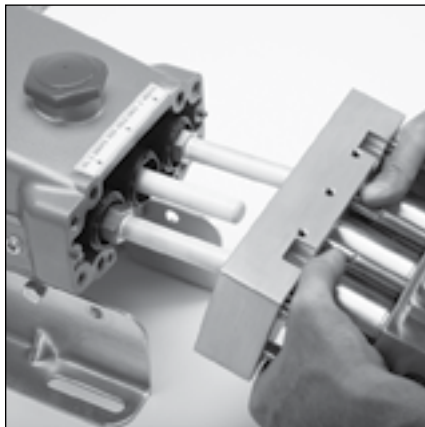

3.2 Pull complete head assembly carefully over ceramic plungers and place on a flat surface with the housing block side facing upwards.



3.3 Use a M10 Allen Wrench to remove the eight (8) HSH screws that secure the housing block to the IMDM.



3.4 Pull housing block away from IMDM.



3.5 Remove outer cylinder with seal case assembly from IMDM.



3.6 Remove low pressure seals and o-rings from each seal case.



3.7 Remove seal case assembly from each outer cylinder.

DISASSEMBLY CONTINUED



3.8 Remove V/P cylinders from IMDM.

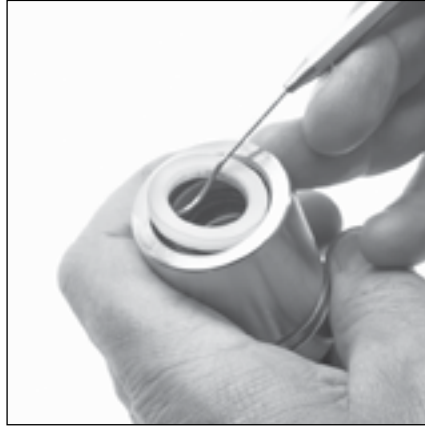

3.9 Remove female adapter from each V/P cylinder.



3.10 Remove v-packings (qty 3) from each V/P cylinder.



3.11 Remove male adapter from each V/P cylinder.

NOTE: Remove o-ring and backup-rings from each V/P cylinder.

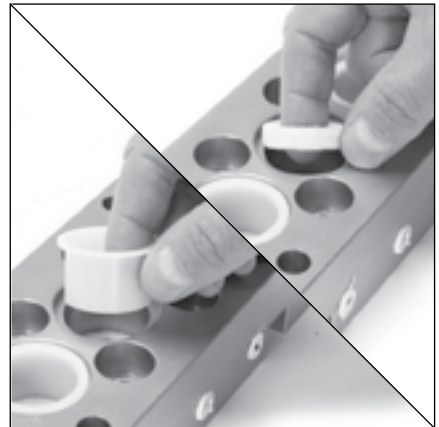

3.12 Remove collars and wicks from crankcase side of housing block.



3.13 Inspect all parts per NOTES

NOTE: Examine low pressure seals and v-packings for wear and replace with a new seal kit as needed.

NOTE: Examine o-rings, backup-rings and wicks for cuts or wear and replace with a new seal kit as needed.

NOTE: Examine collars for wear or damage and replace individually as needed.

NOTE: Examine female adapters for grooves, pitting or wear and replace with a new seal kit as needed.

NOTE: Examine male adapters for grooves, pitting or wear and replace individually as needed.

NOTE: Examine seal case, outer cylinder and V/P cylinders for wear or damage and replace individually as needed.

REASSEMBLY



3.14 Install brass male adapter with flat surface down into each V/P cylinder.



3.15 Lubricate and install v-packings with v-grooved side down into each V/P cylinder. Each cylinder requires three (3) v-packings.



3.16 Install female adapter with v-grooved side facing down into each V/P cylinder.

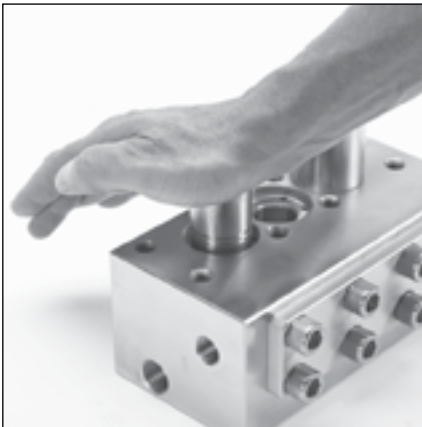

3.17 Lubricate and install backup-ring and then o-ring onto small end of each V/P cylinder. Position small end of each V/P cylinder into the IMDM and press into place.



3.18 Lubricate and install o-ring into groove of each outer cylinder. Slide outer cylinder over each V/P cylinder and hand press into IMDM.



3.19 Lubricate outside diameter of each low pressure seal and inside diameter of each seal case. Install low pressure seal with spring side down into each seal case.



3.20 Lubricate seal case o-ring and inside diameter of each outer cylinder. Hand press each seal case assembly with low pressure seal facing outwards into outer cylinder.

REASSEMBLY CONTINUED

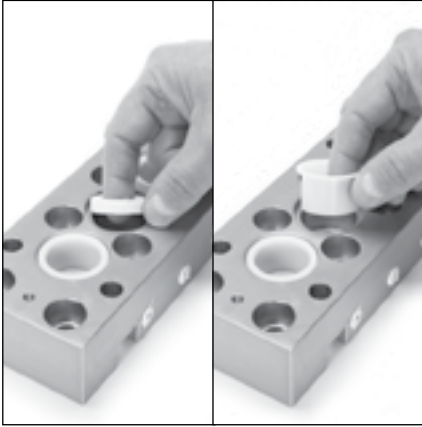

3.21 Install wicks and then collars into crankcase side of housing block.

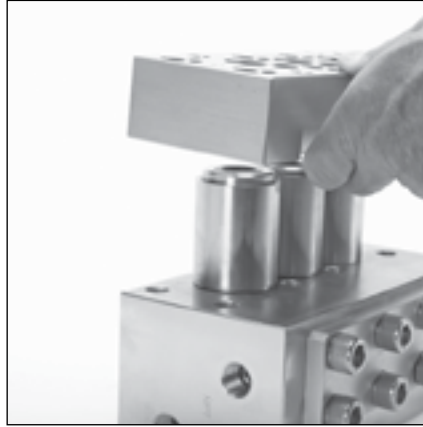

3.22 Position housing block with counter-bore surfaces facing downward over outer cylinders.

NOTE: Apply anti-sieze lubricant (PN 6119) to threaded ends of all eight (8) HSH screws and hand thread into position.

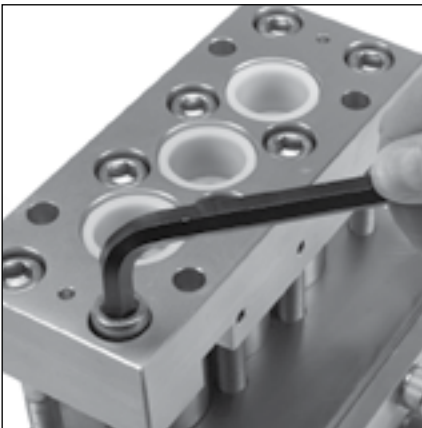

3.23 Use a M10 Allen Wrench to torque all eight (8) HSH screws to 398 in lbs, 33 ft lbs or 45 Nm in sequence show.

TORQUE SEQUENCE

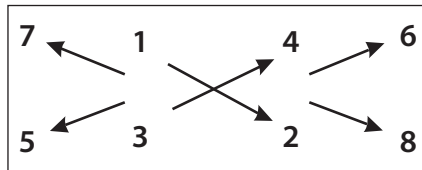

NOTICE

Exercise extreme caution when installing head assembly. The weight of the head assembly or any twisting action can damage the ceramic plungers.

Rotate crankshaft by hand so the two outside plungers are extended equally.

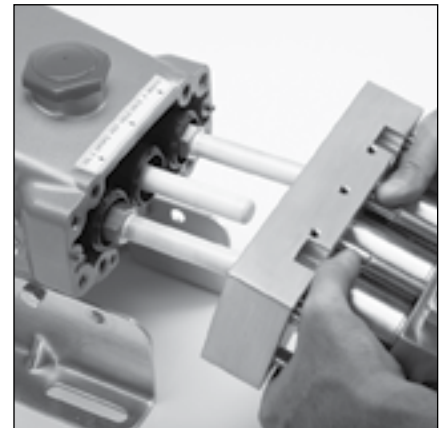

3.24 Slide complete head assembly carefully over ceramic plungers until flush against crankcase.

NOTE: Apply Loctite®242® to threaded ends of all four (4) HSH screws and hand thread into position.

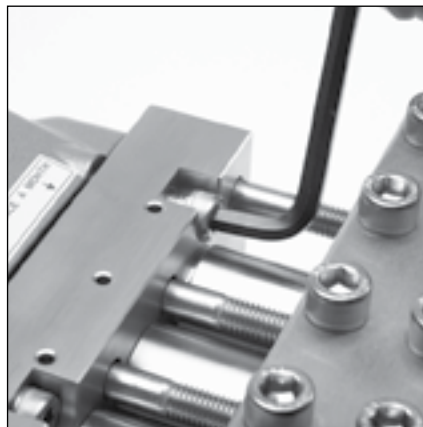

3.25 Use a M8 Allen Wrench to torque all four (4) HSH screws to 531 in lbs, 44 ft lbs or 60 Nm in sequence show.

TORQUE SEQUENCE

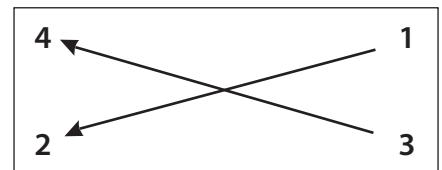

Servicing the Plungers

DISASSEMBLY

NOTE: Servicing the plungers must be done by removing the IMDM and housing block.



4.0 Remove IMDM and housing block as a complete assembly.



4.1 Remove seal retainers from crankcase.



4.2 Use a 7/8" wrench to remove plunger assembly from each plunger rod.

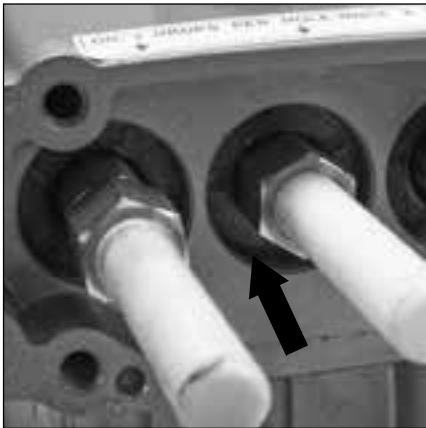

4.3 Inspect all three (3) crankcase oil seals and plunger rods for damage or oil leakage. Contact Cat Pumps for proper instructions on removal of these oil seals.

NOTE: Inspect all three (3) plunger assemblies for cracks, pitting and scoring and replace individually as needed.

REASSEMBLY



4.4 Install plunger assembly onto each plunger rod.



4.5 Use a 7/8" wrench to torque the three (3) plunger assemblies to 398 in lbs, 33 ft lbs or 45 Nm.

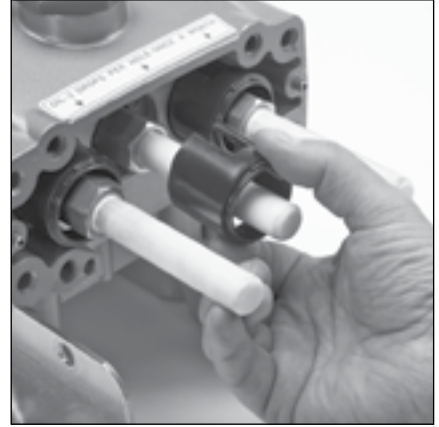

4.6 Install seal retainers with slot opening facing upwards and the small stepped diameter facing the manifold.

NOTE: Apply a light grease to the end each plunger.

NOTE: Rotate crankshaft by hand so the two outside plungers are extended equally.

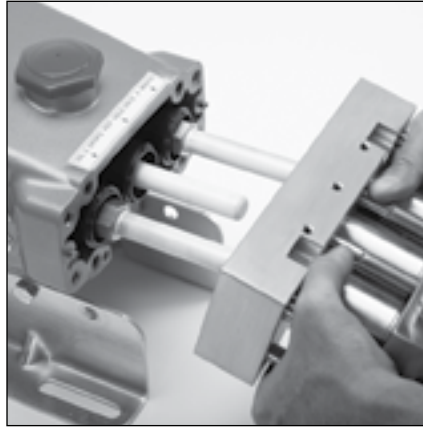

4.7 Slide complete head assembly carefully over ceramic plungers until flush against crankcase.

NOTICE

Exercise extreme caution when installing head assembly. The weight of the head assembly or any twisting action can damage the ceramic plungers.

NOTE: Apply Loctite®242® to threaded ends of all four (4) HSH screws and hand thread into position.

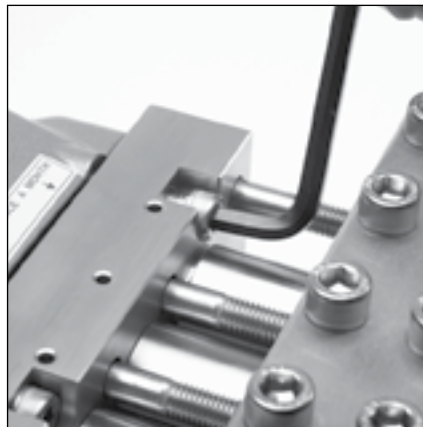

4.8 Use a M8 Allen Wrench to torque all four (4) HSH screws to 531 in lbs, 44 ft lbs or 60 Nm in sequence show.

TORQUE SEQUENCE

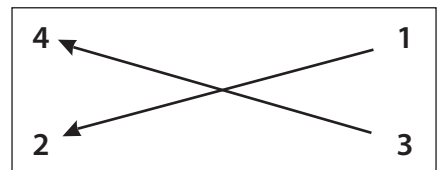

NOTE: Visually inspect bubble oil gauge, drain plug, bearing covers and rear cover for oil leakage. Replace individually as needed.

Safety

IMPORTANT SAFETY INSTRUCTIONS

It is the responsibility of the user to read and understand all instructions, important safeguards, and safety precautions before operating or servicing any pump. Failure to do so may result in property damage, personal injury or death.

GENERAL SAFETY INFORMATION AND SYMBOLS

Pay special attention to the following signal words, safety alert symbols and statements:

⚠ DANGER

Indicates a hazardous situation which, if not avoided, will result in death or serious injury.

⚠ CAUTION

Indicates a hazardous situation which, if not avoided, could result in minor or moderate injury or property damage.

⚠ WARNING

Indicates a hazardous situation which, if not avoided, could result in death or serious injury.

NOTICE

Indicates a hazardous situation which, if not avoided, could result in property damage.

⚠ Indicates a potential personal injury hazard. Obey all safety messages that follow this symbol to avoid possible injury or death.

Safety Hazards

⚠ DANGER

A. FLAMMABLE OR EXPLOSIVE LIQUID HAZARD

Do not operate pump with flammable or explosive liquids unless extraordinary safety precautions are observed. Leaks of flammable or explosive liquids, if exposed to elevated temperatures, static electricity, sparks or other hazards, will result in flame or possible explosion, causing serious personal injury, death or property damage.

1. Before operating pump with flammable or explosive liquids, ensure proper maintenance has been performed.
2. Do not operate pump with flammable or explosive liquids if leaks are detected.
3. Only pump flammable or explosive liquids that are compatible with pump component materials.
4. Do not operate pump with flammable or explosive liquids without safeguards or safety systems to detect leaks, elevated temperatures, spark prevention or any other hazards defined by the NFPA systems.
5. Do not remove Flammable Liquids Product Suitability Hang Tag to assure proper safety.
6. Follow ATEX guidelines for potentially explosive atmospheres.

⚠ WARNING

A. ELECTRICAL SHOCK HAZARD

Do not service pump or electrical equipment while energized. Electricity can cause personal injury, death or property damage.

1. Adhere to "Lock Out" and "Tag Out" procedures for electrical equipment.
2. Before commencing pump service, turn power supply off.
3. Keep water away from electrical outlets and electrical devices.
4. Electrical components must be installed by a qualified electrician to avoid risk of electrocution.

B. ROTATING PARTS HAZARD

Do not service pump while energized. Moving, rotating or reciprocating parts can crush and cut, causing personal injury, death or property damage.

1. Adhere to "Lock Out" and "Tag Out" procedures for electrical equipment.
2. Before commencing pump service, turn power supply off, turn water supply off, squeeze trigger on gun to relieve system pressure.
3. For mobile equipment, be sure engines and hydraulics are turned off and secured to avoid accidental start.
4. Do not operate with safety guards removed.
5. Always use safety guards on all belt drives, couplings and shafts.

C. HOT SURFACE HAZARD

Do not touch pump, accessories or drive system while operating and until cool down is complete. Touching hot surface areas of the pump, accessories or drive system can cause severe burns or personal injury.

D. SKIN PUNCTURE HAZARD

Do not allow spray to contact any part of the body or animals. Pumped liquids under high pressure can pierce skin and underlying tissue or can deflect debris leading to serious personal injury or death.

1. Relieve all line pressure in the inlet line to the pump and discharge line from the pump before performing any maintenance on the pump.

⚠ WARNING

Continued

2. When high pressure gun is not in use, set safety trigger lock (safety latch) to avoid accidental high pressure operation and personal injury or property damage.
3. Do not check for leaks with hand. Use a piece of cardboard to check for leaks.
4. Review cleaning procedures to minimize heavy back blasting.
5. Wear adequate safety equipment and clothing when operating high pressure sprayer. Never use high pressure spray with bare feet or exposed skin, and always wear safety glasses.

E. PUMPING LIQUIDS HAZARD

Do not operate pump with hot water, chemicals, or other hazardous liquids unless extraordinary safety precautions are observed. Pumping hot water, chemicals, or other hazardous liquids can expose personnel to serious injury.

1. Provide guards or shields around equipment to protect personnel.
2. Wear mask, goggles or eye protection while operating high pressure equipment.
3. Obtain a material safety data sheet (MSDS) and take appropriate safety measures for the liquid being handled.

F. OVER PRESSURIZATION HAZARD

Do not operate high pressure pumping system unless extraordinary safety precautions are observed. A high pressure pumping system can deadhead or over pressurize causing serious personal injury and property damage.

1. All high pressure systems require a primary pressure regulating device (i.e., regulator or unloader) and a secondary pressure safety relief device (i.e., pop-off valve, safety valve, rupture disc) to assure proper pressure setting and overpressure protection.
2. All high pressure systems require a pressure gauge to monitor pressure settings and avoid overpressure of equipment or personal harm.
3. Install primary pressure relief device on the discharge side of the pump.
4. Install secondary pressure relief device between the primary device and pump.
5. Install pressure gauge onto the discharge manifold or in the discharge line near the manifold.
6. Open all valves on discharge side of plumbing before operation.

G. OXYGEN HAZARD

Do not charge Prrrrr-O-Lators (Pulsation Dampeners) with oxygen. Oxygen may cause an explosion causing personal injury, death or property damage.

1. Use nitrogen only when charging pulsation dampeners, DO NOT USE OXYGEN.
2. Use proper charging tools to charge pulsation dampeners.
3. Charge pulsation dampener within specifications stated on data sheet to assure proper pulsation dampening and prevent failure of bladder.

H. FALL HAZARD

Do not operate pressure washer while standing on slippery or unstable surface unless extraordinary safety precautions are observed. Pressure washing may create slippery surface on which a person may slip and fall causing personal injury or death.

1. Wear suitable footwear to maintain a good grip on wet surfaces.
2. Do not stand on ladders or scaffolding.
3. Do not over reach or stand on unstable supports.
4. Keep good footing and balance and hold gun with both hands to control kick back.

⚠ CAUTION

A. IMPROPER USE OF FITTINGS HAZARD

Do not operate the pump with improperly connected, sized, worn or loose fittings, pipes or hoses. Operating the pump under these conditions could result in personal injury and property damage.

1. Ensure all fittings, pipes and hoses are properly rated for the maximum pressure rating and flow of the pump.
2. Check all fittings and pipes for cracks or damaged threads.
3. Check all hoses for cuts, wear, leaks, kinks or collapse before each use.
4. Ensure all connections are tight and secure.
5. Use PTFE thread tape or pipe thread sealant (sparingly) to reconnect plumbing. Do not wrap tape beyond the last thread, this will prevent tape from becoming lodged in the pump or accessories.
6. Apply proper sealants to assure secure fit or easy disassembly when servicing.

B. FROZEN LIQUID HAZARD

Do not operate the pump with frozen liquid. Operating the pump under this condition could over pressurize and jettison the manifold from the crankcase causing personal injury and property damage.

1. Store pump or pumping system in an environmentally controlled room protected from freezing temperatures.
2. Follow procedures in TECH BULLETIN 083 to winterize pump.

CAUTION

Continued

C. CLEANING PUMP HAZARD

Do not use solvents that are flammable and toxic to clean or degrease equipment. Use of these solvents could result in personal injury and property damage.

1. Follow safety instructions as found in MSDS or on packaging of each liquid.
2. Clean equipment in a well ventilated area.
3. Disposal of solvents to be in accordance with local, state and federal regulations.

D. OPERATING BEYOND SPECIFICATIONS HAZARD

Do not operate the pump outside the specifications of individual pump data sheet or service manual. Operating the pump under these conditions could result in personal injury and property damage.

1. Do not operate the pump faster than the maximum recommended RPM.
2. Do not operate the pump at pressures higher than the maximum recommended pressure.
3. Do not operate the pump at temperatures higher than the maximum recommended temperatures.
4. Do not use accessories that are not compatible or rated for the pump.

E. LIFTING DEVICE HAZARD

Do not lift pump with unsuitable lifting devices. Use of unsuitable lifting devices may cause pump to fall resulting in personal injury, damage to pump and/or pump with drive/base plate.

1. Lifting eyes installed on the pump must be used only to lift the pump.
2. Special lifting eyes should be installed on the base for lifting the pumping system (i.e. base, drive and accessories)
3. If slings or chains are used for lifting, they must be safely and securely attached to properly balance the weight of the unit.
4. Inspect slings and chains prior to use and replace worn and damaged slings and chains.

NOTICE**A. ROTATION OF PUMP HAZARD**

Do not rotate pump crankshaft in reverse direction. Rotation of pump crankshaft in reverse direction may not provide proper lubrication and may result in damage to the drive-end components.

1. Forward rotation is the top of the crankshaft turning towards the manifold head of the pump.
2. Ensure oil is filled to the center red dot on sight gauge for forward rotation.
3. Ensure oil is filled to slightly above center red dot on sight gauge for reverse rotation.

B. BELT TENSION HAZARD

Do not operate pump with excessive belt tension. Excessive belt tension may damage the pumps bearings or reduce horsepower.

1. Rotate pump crankshaft before starting to ensure shaft and bearings are moving freely.
2. Ensure pulleys are properly sized.
3. Periodically replace belts to assure full horsepower transmission.
4. Ensure center distance dimensions between pulleys is correct.

C. BY-PASS OPERATION HAZARD

Do not operate the pump in by-pass for extended lengths of time. Operating the pump under this condition can quickly cause heat build-up resulting in damage to the pump.

1. Route by-pass line to supply reservoir to dissipate heated by-pass liquid into a large reservoir of cool water to reduce excessive temperature build-up.
2. Route by-pass line to inlet of pump using a thermo valve in the by-pass line or auto shut-off assembly that will sense temperature rise and either by-pass or shut down system before damage occurs.

D. DRY OPERATION HAZARD

Do not operate the pump without water or liquid. Operating pump under these conditions could result in damage to the pump.

1. Open all valves on inlet side of pump before starting operation to prevent starving the pump.
2. Do not exceed inlet suction pressure limit specified in pump Data Sheet.
3. Ensure inlet feed exceeds the maximum flow being delivered by the pump.
4. Ensure all fittings, pipes and hoses are properly sized for the pump to avoid restricted flow.
5. Review and implement all other recommendations appropriate for your system from the Inlet Condition Check-List.

DIAGNOSIS AND MAINTENANCE

One of the most important steps in a high pressure system is to establish a regular maintenance program. This will vary slightly with each system and is determined by various elements such as the duty cycle, the liquid being pumped, the actual specifications vs rated specifications of the pump, the ambient conditions, the inlet conditions and the accessories in the system. A careful review of the necessary inlet conditions and protection devices required before the system is installed will eliminate many potential problems. Cat Pumps are very easy pumps to service and require far less frequent service than most pumps. Typically, only common tools are required, making in-field service convenient, however, there are a few custom tools, special to certain models, that do simplify the process. This service manual is designed to assist you with the disassembly and reassembly of your pump. The following guide will assist in determining the cause and remedy to various operating conditions. You can also review our **FAQ** or **SERVICE** sections on our **WEB SITE** for more facts or contact Cat Pumps directly.

PROBLEM	PROBABLE CAUSE	SOLUTION	
Low pressure	<ul style="list-style-type: none"> • Worn nozzle. • Air leak in inlet plumbing. • Pressure gauge inoperative or not registering accurately. • Relief valve stuck, partially plugged or improperly adjusted. • Inlet suction strainer (filter) clogged or improperly sized. • Abrasives in pumped liquid. • Leaky discharge hose. • Inadequate liquid supply. • Severe cavitation. • Worn seals. • Worn or dirty inlet/discharge valves. 	<ul style="list-style-type: none"> • Replace with proper size nozzle. • Tighten fittings and hoses. Use PTFE liquid or tape. • Check with new gauge. Replace worn or damaged gauge. • Clean/adjust relief valve. Replace worn seats/valves and o-rings. • Clean filter. Use adequate size filter. Check more frequently. • Install proper filter. • Replace discharge hose with proper rating for system. • Pressurize inlet. • Check inlet conditions. • Install new seal kit. Increase frequency of service. • Clean inlet/discharge valves or install new valve kit. 	
Pulsation	<ul style="list-style-type: none"> • Foreign material trapped in inlet/discharge valves. 	<ul style="list-style-type: none"> • Clean inlet/discharge valves or install new valve kit. 	
Water leak	<ul style="list-style-type: none"> • Under the manifold • Into the crankcase 	<ul style="list-style-type: none"> • Worn V-Packings or Lo-Pressure Seals. • Humid air condensing into water inside the crankcase. • Excessive wear to V-Packings and Lo-Pressure seals. 	<ul style="list-style-type: none"> • Install new seal kit. Increase frequency of service. • Install new oil cap protector. Change oil every 3 months or 500 hours. • Install new seal kit. Increase frequency of service.
Knocking noise	<ul style="list-style-type: none"> • Inlet supply • Bearing 	<ul style="list-style-type: none"> • Inadequate inlet liquid supply. • Broken or worn bearing. 	<ul style="list-style-type: none"> • Check liquid supply. Increase line size or pressurize. • Replace bearing.
Oil leak	<ul style="list-style-type: none"> • Crankcase oil seal • Crankshaft oil seal and o-ring • Drain plug • Bubble oil gauge • Bearing cover • Filler cap 	<ul style="list-style-type: none"> • Worn crankcase oil seal. • Worn crankshaft oil seal or o-ring on bearing cover. • Loose drain plug or worn drain plug o-ring. • Loose bubble oil gauge or worn bubble oil gauge gasket • Loose bearing cover or worn bearing cover o-ring. • Loose filler cap or excessive oil in crankcase. 	<ul style="list-style-type: none"> • Replace crankcase oil seal. • Remove bearing cover and replace o-ring and/or oil seal. • Tighten drain plug or replace o-ring. • Tighten bubble oil gauge or replace gasket. • Tighten bearing cover or replace o-ring. • Tighten filler cap. Fill crankcase to specified capacity.
Pump runs extremely rough	<ul style="list-style-type: none"> • Inlet conditions • Pump valves • Pump seals 	<ul style="list-style-type: none"> • Restricted inlet or air entering the inlet plumbing • Stuck inlet/discharge valves. • Leaking V-Packings or Lo-Pressure seals. 	<ul style="list-style-type: none"> • Correct inlet size plumbing. Check for air tight seal. • Clean out foreign material or install new valve kit. • Install new seal kit. Increase frequency of service.
Premature seal failure	<ul style="list-style-type: none"> • Scored plunger. • Over pressure to inlet manifold. • Abrasive material in the liquid being pumped. • Excessive pressure and/or temperature of pumped liquid. • Running pump dry. • Starving pump of adequate liquid. • Eroded manifold. 	<ul style="list-style-type: none"> • Replace plunger. • Reduce inlet pressure per specifications. • Install proper filtration at pump inlet and clean regularly. • Check pressure and inlet liquid temperature. • DO NOT RUN PUMP WITHOUT LIQUID. • Increase hose one size larger than inlet port size. • Replace manifold. Check liquid compatibility. 	



CAT PUMPS

1681 - 94TH LANE N.E. MINNEAPOLIS, MN 55449-4324
 PHONE (763) 780-5440 — FAX (763) 780-2958
 e-mail: techsupport@catpumps.com
 www.catpumps.com